

The ERTMS/ETCS signalling system

An overview on the Standard European Interoperable signalling and train control system

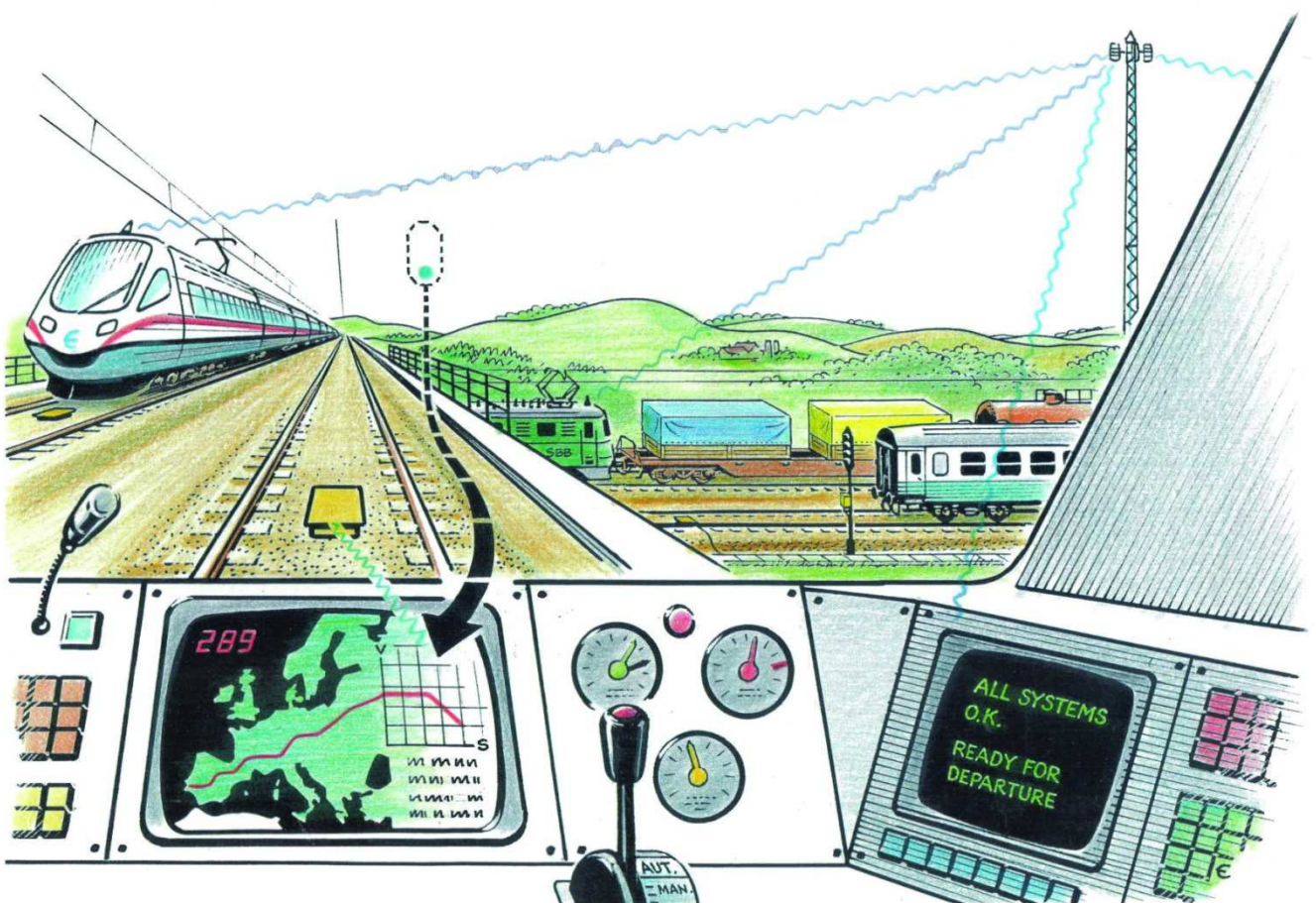

railwaysignalling.eu		London 9A Devonshire Square EC2M 4YTE London - UK
DATE	AUTHOR	
27/08/2014	Maurizio Palumbo	

REVISIONS

Version	Author	Date	Pages	Comments
A	Maurizio Palumbo	27/07/2012	41	First release
B	Maurizio Palumbo	08/10/2012	44	Paragraph §5.3 upgraded
C	Maurizio Palumbo	19/04/2013	51	<ul style="list-style-type: none"> ▪ Formatting of the document modified; ▪ Integration of the attachment 1 "Railway Engineering Basis.ppt" ▪ Integration of the ATS specification; ▪ Integration of the trainborne equipment and functionalities;
D	Maurizio Palumbo	27/08/2014	57	General modifications
E	Maurizio Palumbo Michele Ruscigno	29/10/2014	60	Integration to chapters: <ul style="list-style-type: none"> ▪ DMI ▪ Dynamic speed monitoring ▪ Operating Mode
F	Maurizio Palumbo Michele Ruscigno Jodi Scalise	15/03/2015	61	Introduction to train detection and protection technologies

CONTENTS

1	INTRODUCTION	6
1.1	CONTEXT.....	6
1.2	PURPOSE AND RECIPIENTS.....	6
1.3	CONTENTS.....	6
1.4	REFERENCE DOCUMENTS AND ARTICLES	7
1.5	ACRONYMS, ABBREVIATIONS AND DEFINITIONS	8
1.6	ABOUT THE AUTHORS	10
2	SOME HISTORY ABOUT RAILWAY SIGNALLING.....	11
2.1	EVOLUTION OF SIGNALLING BLOCK SYSTEMS.....	11
2.1.1	THE TRACK CIRCUIT	12
2.1.2	THE AXLE COUNTER.....	13
2.2	ATP SYSTEMS.....	14
2.3	SAFE BRAKING CURVE	15
2.4	FROM NATIONAL ATP TO ERTMS/ETCS	16
3	HS/HC RAILWAY LINES.....	18
3.1	DEFINITIONS.....	18
3.2	TARGETS.....	18
3.3	IMPLEMENTATION IN EUROPE.....	19
3.4	IMPLEMENTATION IN ITALY	20
3.4.1	ERTMS/ETCS	20
3.4.2	GSM-R.....	20
3.4.3	CSS - HS	21
4	ERTMS PROGRAMME	22
4.1	SOME HISTORY ABOUT ERTMS	22
4.2	ADVANTAGES OF ERTMS	23
4.3	MODIFICATION OF ERTMS/ETCS SPECIFICATIONS	24
5	ETCS COMMAND-CONTROL AND SIGNALLING SYSTEM	26
5.1	ETCS LEVELS.....	26
5.1.1	ETCS - LEVEL 0	26
5.1.2	ETCS - LEVEL 1	26
5.1.3	ETCS - LEVEL 2	27
5.1.4	ETCS - LEVEL 3	28
5.2	ARCHITECTURAL DESCRIPTION	30
5.2.1	TRACKSIDE SUBSYSTEM	31
5.2.1.1	ETCS	31
5.2.1.1.1	RBCs	32
5.2.1.1.2	NTG	33
5.2.1.1.3	KMS.....	33
5.2.1.1.4	EUROBALISES	33
5.2.1.1.5	LEU	34
5.2.1.1.6	MARKER BOARDS	34
5.2.1.2	IXL.....	35
5.2.1.3	ATS.....	36
5.2.2	TRAINBORNE SUBSYSTEM	37
5.2.2.1	EVC	37
5.2.2.2	DMI	37
5.2.2.3	Odometry subsystem.....	39
5.2.2.3.1	Wheel Sensor	40
5.2.2.3.2	Radar	40
5.2.2.3.3	Accelerometer.....	41
5.3	FUNCTIONAL DESCRIPTION	42
5.3.1	TRACKSIDE SUBSYSTEM	42
5.3.1.1	IMPROVED SAFETY	42
5.3.1.1.1	Movement Authority	42
5.3.1.1.2	Temporary Speed Restriction	43

5.3.1.1.3	Dynamic Speed Monitoring	44
5.3.1.1.4	Detectors	45
5.3.1.2	ASSURED INTEROPERABILITY	45
5.3.1.2.1	Entrance Transition Announcement	45
5.3.1.2.2	First Movement Authority	45
5.3.1.2.3	Entrance with train not fitted with ERTMS/ETCS L2	46
5.3.1.3	IMPROVED PERFORMANCE	46
5.3.1.3.1	INCREASED INFRASTRUCTURE CAPACITY	46
5.3.2	TRAINBORNE SUBSYSTEM	49
5.3.2.1	OPERATING MODE	49
5.3.2.2	START OF MISSION	51
5.3.2.3	INCREASED SPEED	52
5.3.3	INTERFACE BETWEEN TRACKSIDE AND TRAINBORNE SUBSYSTEMS	53
5.3.3.1	RADIO Interface	53
5.3.3.1.1	GSM-R	53
5.3.3.1.2	GPRS-R	54
5.3.3.2	AIR Gap Interface	55
5.3.3.3	ERTMS/ETCS Language	56
5.3.3.3.1	Variables	56
5.3.3.3.2	Packets	57
5.3.3.3.3	Messages	57
5.3.3.4	ERTMS Security	59

LIST OF FIGURES

Attachment 1: Railway Engineering Basis	7
Figure 2: Phone block system	11
Figure 3: track circuit with unoccupied block.....	12
Figure 4: track circuit with occupied block.....	13
Figure 5: Schematic of Axle Counter system	14
Figure 6: History of signalling systems	15
Figure 7: Safe Braking Model	16
Figure 8: the diversity of European ATP systems.....	16
Figure 9: Journey time improvements on the HS/HC Italian line <i>Milan-Naples</i>	18
Figure 10: HS/HC railway European network	19
Figure 11: Frequency allocation in 900 MHz-Band	21
Figure 12: GSM-R Architecture.....	21
Figure 13: Hierarchic document level.....	22
Figure 14: Performance increase with ERTMS	23
Figure 15: ERA logo.....	24
Figure 16: <i>Change Request</i> process for ERTMS/ETCS specifications	25
Figure 17: ETCS – Level 1 operation diagram	27
Figure 18: indicator panels	27
Figure 19: Exchange of information between RBC and trainborne.....	28
Figure 20: ETCS – Level 2 operation diagram	28
Figure 21: ETCS – Level 3 operational diagrams	29
Figure 22: HS/HC railway transport system	30
Figure 23: Communication of the trackside subsystem with other ERTMS L2 elements	31
Figure 24: RBCs area governance responsibility	32
Figure 25: Eurobalises on a railway track	34
Figure 26: ERTMS/ETCS Marker boards	34
Figure 27: Two possible routes from A to B	35
Figure 28: HS/HC Bologna TCC	36
Figure 29: ERTMS/ETCS Cockpit.....	37
Figure 30: ETCS DMI monitor.....	39
Figure 31: Simplified On-Board System.....	40
Figure 32: Wheel Sensor	40
Figure 33: Radar Sensor	41
Figure 34: Accelerometer.....	41
Figure 35: Allocation of a Movement authority.....	42
Figure 36: Allocation of a temporary speed restriction	43
Figure 37: Rail capacity parameters.....	47
Figure 38: TGV speed world record	53
Figure 39: Interface between Trackside and Trainborne Subsystems	53
Figure 40: GPRS-R Architecture	54
Figure 41: Air Gap Interface.....	56
Figure 42: Triggering functions for "Message 2: SR Authorization"	58

LIST OF TABLES

Table 1: Reference Document Table	8
Table 2: Acronyms, Abbreviations and Definitions	9
Table 3: Technical features of the HS/HC rail lines.....	20
Table 4: Colour DMI criteria	38
Table 5: Short description of rail capacity terminology.....	46
Table 6: Variable "NID_LX"	56
Table 7: Structure of an ERTMS/ETCS Packet	57
Table 8: Message 2 - SR Authorization	58
Table 9: Message 3: Movement Authority.....	59

1 INTRODUCTION

1.1 Context

railwaysignalling.eu is a technical e-journal and web community.

It was born and grows with the purpose to share high-tech knowledge about the most advanced and widespread signalling and train control European solutions.

Young and experienced rail-signal engineers are welcome to participate to the group's web community, by publishing their own technical articles about the main topics of railway signalling and train control European solution.

railwaysignalling.eu believes in the positive effect of the global market, which allows everyone to grow personally and professionally, to get in touch with different cultures and increase knowledge of people close to your way of thinking and/or your business.

The continuous refinement of the global market and the removal of the concept of national borders are strictly related to the possibility to move quickly, easily and comfortably, covering small or wide distances while respecting the environment. Our work wants to be a contribution to the development of smart/eco-friendly transportation's, to reduce the physical and psychological distance among countries in Europe.

1.2 Purpose and recipients

Inside this framework, this handbook gives an overall description of railway signalling with a major focus to **ERTMS/ETCS signalling and train control**, to introduce to the main topics all engineers interested or involved in railway signalling projects.

Since the handbook is not a detailed manual, through the cross-references [Ri] inside the document you can refer to Table 1 for further details about all main topics here covered.

1.3 Contents

This document is divided into the following chapters:

- §2 presents a brief history of the **railway signalling**. With an excursus among the signalling basic concepts from nineteenth century to nowadays, it introduces to the birth of ERTMS programme.
- §3 describes, from an architectural and a functional point of view, the main features of the European **HS/HC railway lines**, with a special focus on the Italian national high speed railways, on which ETCS Level 2 is adopted.
- §4 presents a brief history of the **ERTMS programme**, explaining the reasons for which it was born, its main subsystems and the change specification process. Furthermore, it introduces the main advantages consequent by the adoption of this standard.

- §5 as core of the paper, it describes the main features of **ETCS command-control and signalling system**, component of the ERTMS programme. After listing all the possible ETCS levels of applications, ETCS L2 signalling system is described in more detail, from an architectural and a functional point of view.

Furthermore, a slideshow about the basis of railway engineering (market, infrastructure, signalling) is attached below. It can be useful to obtain a general overview about railway technology and then get the main concept of signalling, better specified in this document. This presentation is currently available only in Italian language.



Railway engineering
basis.ppt

Attachment 1: Railway Engineering Basis

1.4 Reference Documents and Articles

REF.	TITLE	AUTHOR
[R1]	The Core of ATP - Data Engineering	W. Kaiser, S. Nielson
[R2]	Invensys Rail - ERTMS	Invensys Rail
[R3]	Sistemi di controllo per l'alta velocità ferroviaria	F. Flammini
[R4]	L'alta velocità italiana	B. Cirillo, P. Comastri
[R5]	ETCS – Development and implementation in Italy	F. Senesi, E. Marzilli
[R6]	ETCS Level 2 for entire Danish network.	Railway Gazette International
[R7]	Madrid-Barcelona at 310 km/h with ETCS Level 2	Railway Gazette International
[R8]	Security is a safety issue in rail communications	P. Lindsday, T. Cant
[R9]	Delivering flexible and reliable rail traffic: a major industrial project for Europe	European Commission. Directorate-General for Energy and Transport
[R10]	GSM-R Technology	gsm-rail.com
[R11]	GSM-R The Railways Integrated Mobile Communication System	Siemens
[R12]	ERTMS/ETCS – Class 1 Safety requirements	UNISIG
[R13]	ETCS Implementation Handbook	Olivier Leveque
[R14]	Odometer Measurements	deuta.com
[R15]	Electronic odometer for rail vehicles - GEL 2510	lenord.de
[R16]	Odometric Estimation for Automatic Train Protection and Control Systems	Department of Energetics, University of Florence
[R17]	Increase of efficiency in wireless train control systems (ETCS L2) by the use of actual Packet-	Institute of Communications Technology

	Oriented Transmission Concepts	Hannover, Germany
[R18]	ERTMS/ETCS FFFIS for Eurobalise – Subset 036	UNISIG
[R19]	ERTMS/ETCS System Requirements Specification – Subset 026	UNISIG
[R20]	ERTMS/ETCS Euroradio FIS – Subset 037	UNISIG
[R21]	ERTMS Key Management GE/RT8403 Issue One - December 2011	Railway Group Standard
[R22]	Interlocking Principles GE/RT0060 Issue Four - June 2003	Railway Group Standard

Table 1: Reference Document Table

1.5 Acronyms, Abbreviations and Definitions

Term	Definition
ATC	Automatic Train Control
ATP	Automatic Train Protection
ATO	Automatic Train Operation
ATS	Automatic Train Service
BL	Base Line
BSC	Base Station Controller
BSS	Base Station Subsystem
BTS	Base Transceiver Station
CCS	Command and control system
CES	Conditional Emergency Stop
CR	Change Request
DMI	Driver Machine Interface
DB	Deutsche Bahn
EMI	Emergency Brake Intervention
ERA	European Railway Agency
ERTMS	European Railway Traffic Management System
ERRI	European Railway Research Institute
ETCS	European Train Control System
EU	European Union
EVC	European Vital Computer
FIS	Functional Interface Specification
FS	Ferrovie dello Stato
GDV	Gestione della Via
GGSN	Gateway GPRS Support Node
GPRS-R	General Packet Radio Service – Railway
GSM-R	Global System for Mobile Communications – Railway
HSSS	High Speed Signalling System
HS/HC	High Speed / High Capacity
LEU	Lineside Electronics Unit

MA	Movement Authority
MMI	Man Machine Interface
MRSP	Most Restrictive Speed Profile
NTG	Network Transmission Gateway
NTP	Network Time Protocol
OBU	On Board Unit
PDP	Packet Data Protocol
RBC	Radio Block Center
SBI	Service Brake Intervention
SDT	Sistema Distanziamento Treni
SGSN	Service GPRS Support Node
SNCF	Société Nationale des Chemins de fer Français
SoM	Start of Mission
STM	Specific Transmission Module
SYRS	System Requirements Specification
TAF	Track Ahead Free
TC	Track Circuit
TCC	Traffic Control Center
TGV	Train à Grande Vitesse
TMS	Traffic Management System
TSI	Technical Specification for Interoperability
TSR	Temporary Speed Restriction
VMMI	Vital Man Machine Interface
UNISIG	Union of European Signalling Companies

Table 2: Acronyms, Abbreviations and Definitions

1.6 About the authors



[Maurizio Palumbo](#) is the founder of [railwaysignalling.eu](#), where he's also known as "Vesuvius". He was born in Naples (Italy) on 26th September 1986. At the end of 2010, he got his degree in Computer Engineering from the University "Federico II" of Naples. He's a young, curious, smiling and enthusiastic computer systems engineer with specific expertise in railway signalling and ERTMS/ETCS (European Railway Traffic Management System / European Train Control System). He has been involved in Systems and Application Engineering activities on three ERTMS schemes (Italy, Denmark and UK) and on a metro project (London tube, UK).



[Michele Ruscigno](#) is a young electronic engineer, graduated with distinction at the Polytechnic of [Bari](#) (Italy). Since the second half of 2013 he's worked as ERTMS Test Engineer. He cultivates a strong passion for transportation and railways systems and one of his goals is to spread his knowledge by means of the web and make the people fall in love with this exciting field. In particular, he's specialized in the trainborne equipments, working on safety requirements for the ETCS onboard subsystem. Since December 2013 he collaborates with [railwaysignalling.eu](#), where he's also known as "Giuninho".



[Jodi Scalise](#) collaborates with [railwaysignalling.eu](#) since September 2014. He got in July 2013 his Master's degree in Electronic Engineering at University of Florence (Italy). He's a curious, proactive and willing to learn engineer. He has worked at ECM S.p.A. in Pistoia, as electronic designer and validation engineer since the beginning of 2011. He has been involved in test and validation of many ETCS subsystems projects. In particular, he's specialized in track circuits technologies, Eurobalise technologies and odometer subsystems.

2 SOME HISTORY ABOUT RAILWAY SIGNALLING

Railway signalling can be defined as all systems used to control railway traffic safely, essentially to prevent trains from colliding.

All railway safety systems, starting from those used since the birth of the first railroads in Europe, to the most advanced systems nowadays used, share a basic concept:

Trains cannot collide with each other if they are not permitted to occupy the same section of track at the same time.

For this reason, railway lines are divided into sections, known as *blocks*. In normal circumstances, only one train is permitted in each block at a time.

2.1 EVOLUTION OF SIGNALLING BLOCK SYSTEMS

In the early days of railways, at the middle of the nineteenth century (1850), men were employed to stand at intervals (blocks) along the line with a stopwatch and they used *hand signals* to inform train drivers that a train was going to pass more or less than a certain number of minutes previously. The watchmen had no way of knowing whether a train had cleared the line ahead, so if a preceding train stopped for any reason, the crew of a following train would have no way of knowing unless it was clearly visible. As a result, accidents were common in the early days of railways.

Helping staff, *semaphores* was introduced at the turn of the century (1900). The signal fell into horizontal position (indicating stop) when the train was going to pass. Such typical signal is shown in the second picture of Figure 6.

With the invention of the electrical telegraph and then of the telephone, it became possible for the staff at a station (*train dispatchers*), to send a message (first a specific number of rings on a bell, then a telephone call) to confirm that a train had passed and that a specific block was finally clear.

About in 1930 the first optical signals were introduced. The whole system was called the ***absolute block system*** or ***phone block system*** and it's represented in Figure 2.

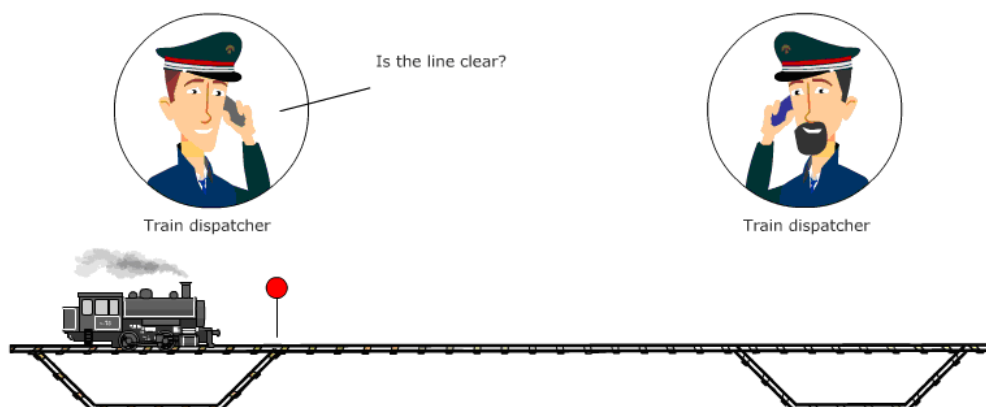

Figure 2: Phone block system

When *fixed mechanical signals* began to replace hand signals from the 1930s, the **semiautomatic block** was born.

Its criteria was analogous to the previous, but the exchange of information between the signal boxes took place via an electric circuit and a system of levers, with which request and grant permission to access the block are sent.

Nowadays, the railway signalling is based on the **automatic block**, which does not require manual intervention.

A line equipped with the signaling system electronic automatic block or **interlocking** is divided into sections of length not shorter than the stopping distance on the faster trains present on the route.

The function of detecting the presence or transit of the vehicles in a particular section is left to a system called **track circuit**.

2.1.1 The track circuit

For this purpose, railway tracks are divided into blocks of varying length. Each block stands out from the adjacent ones by means of an insulated joint between rails and it permits the detection of the presence of a train. Track circuits operational principle is based on an electrical signal impressed between the two running rails. The presence of a train is detected by the electrical connection between the rails, provided by the wheels and the axles of the train (wheel-to-rail shunting).

The basic DC track circuit was invented by Dr. William Robinson and first used in a railway application in 1872. The track circuit consists in a block section defined at each edge by insulated joints on the rails. The insulated joints provide electrical insulation between a track circuit and the adjacent tracks. The signal source (in this case a battery) is connected to the rails at one edge of the block section, while the receiver (a relay) is connected to the other edge.

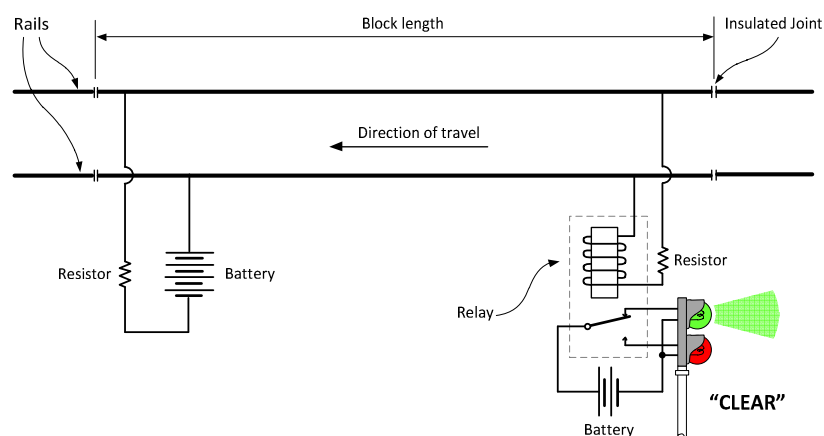

Figure 3: track circuit with unoccupied block

When no train is present, the track circuit is unoccupied, and the direct current supplied by the battery is transmitted by the running rails to the relay and energizes it or “picks it up”. When the relay is energized, the green signal light is turned on (Figure 3).

When a train approaches the block, its wheels and axles connect the two running rails together shorting the battery and thereby reducing to zero the current through the relay. This causes the relay to “drop” (Figure 4), turning off the green signal light and turning on the red light to indicate that the block is occupied by a train. A series resistor with the battery protects it by limiting the current that it must provide when a train is present.

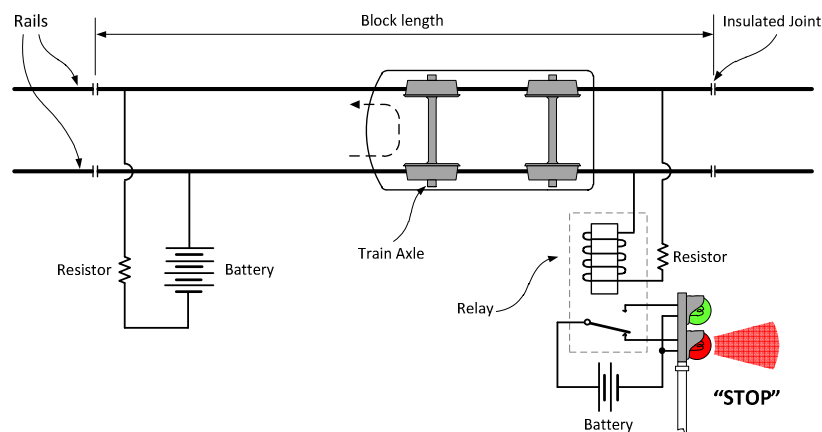

Figure 4: track circuit with occupied block

The track circuit shown here has been simplified for the illustration purpose. In practical application, the relay would have several sets of contacts connected in combination with the contacts of other relays belonging to nearby track circuits to form logic circuits for the control of the signaling devices. Even in the simple form shown in Figure 4, it can be noticed that the breaking of any conductor or the loss of power in the circuit will cause either a red signal or no signal at all to be displayed. A red or “dark” signal must be always interpreted as a stop command. To put it another way, all signaling systems are designed so that a green signal (meaning proceed) is presented only when the track circuits provide positive information that it is safe to do so.

2.1.2 The Axle Counter

An alternative approach to track circuit design uses a “check-in/check-out” logic. Simply stated, this circuit is based on the principle that once a train is detected or “checked in” to a block, it is assumed to be there until it is “checked out” by being detected in an adjacent block. The presence of a train may be detected only intermittently at the time when it enters a new block. Axle counters are installed at each edge of the section of track (Figure 5); when the number of axles counted at the entrance to the section is the same as the number of axles counted at its exit, that means the train has passed through the section.

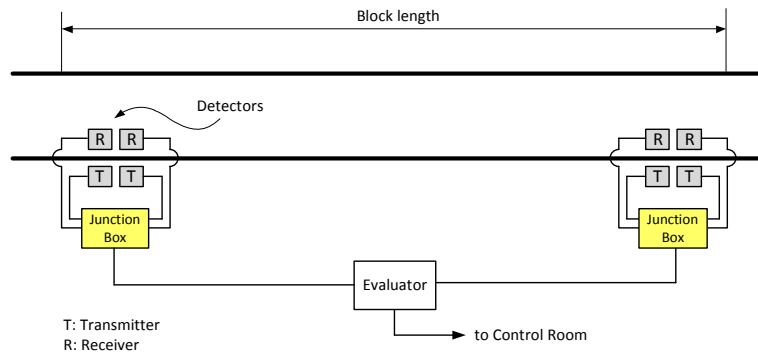

Figure 5: Schematic of Axle Counter system

A detection point comprises two independent couple of detectors, therefore the device can detect the direction of a train by the order in which the detectors are passed. As the train passes a similar counting head at the end of the section, the counter decrements. If the net count is evaluated as zero, the section is presumed to be clear for a second train.

The detector senses the wheels by evaluating the changes in the magnetic coupling between the coils placed at each rail side. The system consists of:

- A sensor coils for train wheels detection;
- An electronic unit (electronic junction box) for signal conditioning and counting of the wheels;
- An evaluator unit which compares the number of the wheels entering the rail section and the wheels exiting the section.

The comparison result states the occupation status (section clear or occupied).

2.2 ATP SYSTEMS

At the beginning of 80s rail signalling systems to increase the railway safety were introduced in Europe, able to constantly monitor the speed of the train. They are called **ATP** (Automatic Train Protection).

First ATP systems used a target speed indication and audible warnings to advise the driver if the train passed a red (danger) signal or exceed a speed restriction. In these cases, the system applied an automatic brake if the driver fails to respond to the warnings. For detailed information, refer to [R1].

Only in the 21s century the **ATC** (Automatic Train Control) systems were born.

ATC realizes an **ATO** (Automatic Train Operation) function, so moves the train without the intervention of the driver, realizing fully driverless systems.

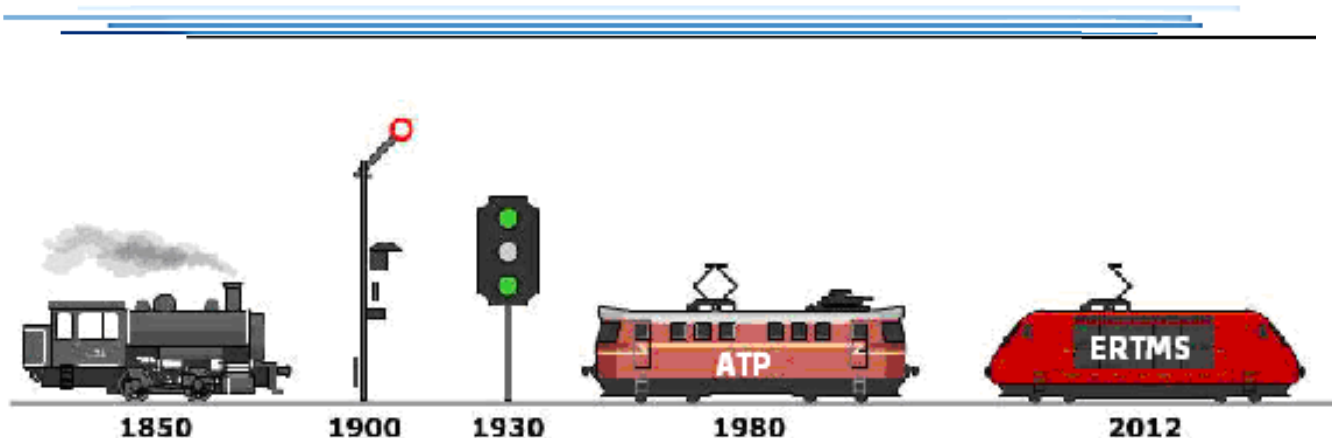

Figure 6: History of signalling systems

2.3 SAFE BRAKING CURVE

One of the key principles of an ATP system is the *braking model* concept, a mathematical model applicable to any land vehicle with a constrained guide.

It allows predicting the maximum safe speed of the vehicle, starting from the following data:

- Target distance (a potential obstacle during the route)
- Current speed
- Physical characteristics of the vehicle

From these data, it's possible to calculate a curve such as that shown in Figure 7. Once known the braking pattern, it's easy to determine what the maximum speed is at which the vehicle can travel, so that it can stop safely before the target\danger point.

The onboard system:

- 1) Receives data packets from the trackside, containing virtual signals and speed restrictions along the line.
- 2) Has the purpose of drawing, instant by instant, the protection curve and verify that the current speed of the train is always below the maximum defined by the model.

If the train is travelling at a speed higher than the maximum, the ATP system intervenes with an automatic brake, reducing the speed.

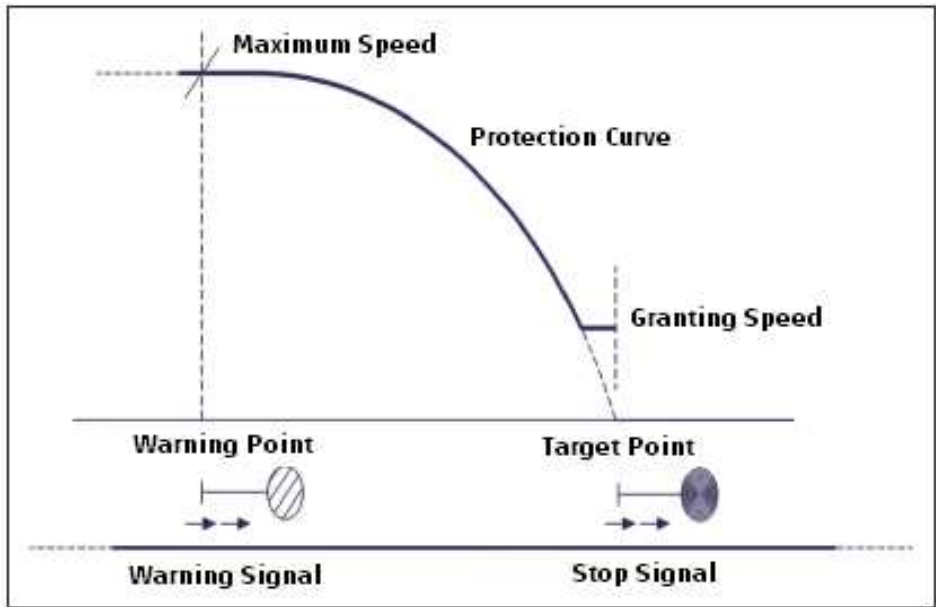

Figure 7: Safe Braking Model

2.4 FROM NATIONAL ATP TO ERTMS/ETCS

Nowadays, all the automated systems that protect the driver and then the train from possible overspeed or exceed of stop signals, are called ATP.

Over the years, in Europe have been developed and operated a lot of different ATP systems, according to the different national requirements, technical standards and operating rules.

The independent development of this incompatible train protection and control systems has contributed to impede the cross-border operation of rail traffic in European network.

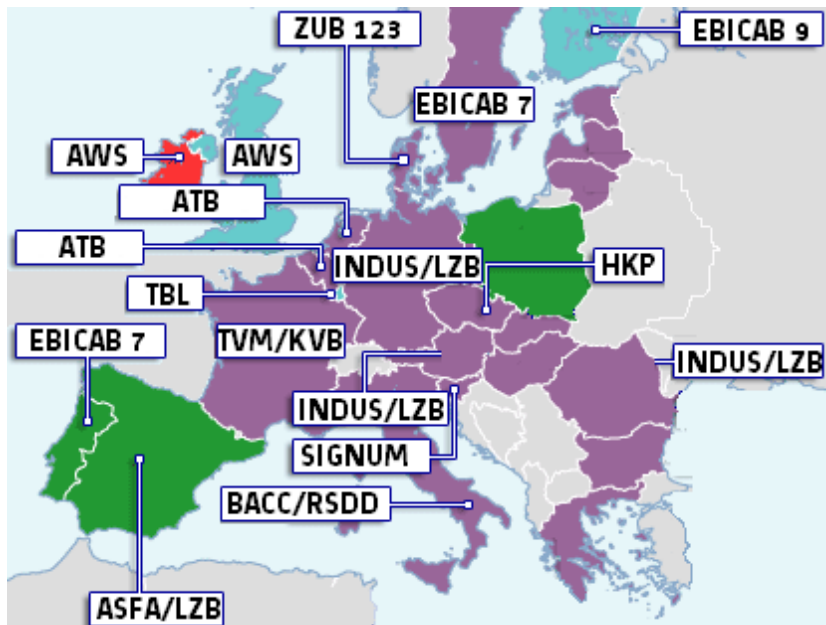

Figure 8: the diversity of European ATP systems

With the advent of European integration there was a need to establish common rules for the free movement of rail networks in all countries.

Following the decision taken by the European Transport minister in December 1989, the EU embarked upon a project to analyze the problems relating to signalling and train control. At the end of 1990, the **ERRI** (European Institute of Railway Research) began to think to develop a common interoperable ATP/ATC system, which could be adopted in all European countries.

As described in details in §4.1, **ERTMS/ETCS** (or simply **ETCS**) has been chosen as the international command-control and signalling system.

Thanks to these standardizations, from the beginning of the 21s century interoperability of the European rail network's guaranteed.

3 HS/HC RAILWAY LINES

Since the EU decision, in 1996, that ERTMS would become the only standard for all HS/HC lines, in a huge number of European states the introduction of the ERTMS/ETCS has been running parallel to and integrates with the HS/HC project.

For this reason, this chapter describes its main features, before talking about standard signalling detailed concepts.

3.1 DEFINITIONS

HS (High Speed)/**HC** (High Capacity) railway is a type of rail transport which operates significantly faster than traditional rail traffic.

It's important to clear the difference about HS and HC concept:

- A high speed rail's a modern line, with heavy armament, with paths where possible and basically straight flat, on which trains run specially, designed to achieve high top speeds.
- The terms "High Capacity" means a rail system to transport both goods train and passengers on HS lines, but sometimes it can refers to advanced systems for the railway traffic control, that allow the passage of a greater number of trains because more controlled and regular.

3.2 TARGETS

The main aims of the HS/HC projects are to transform the European railway network into a High Speed/High Capacity system:

- with an overall capacity of more than twice conventional capacity;
- to upgrade and specialise existing lines for local, regional and goods freight transport;
- to enhance the effectiveness of existing lines, creating connections for port or airports;
- to realize the concept of interoperability (integration with the rail international traffic flows).

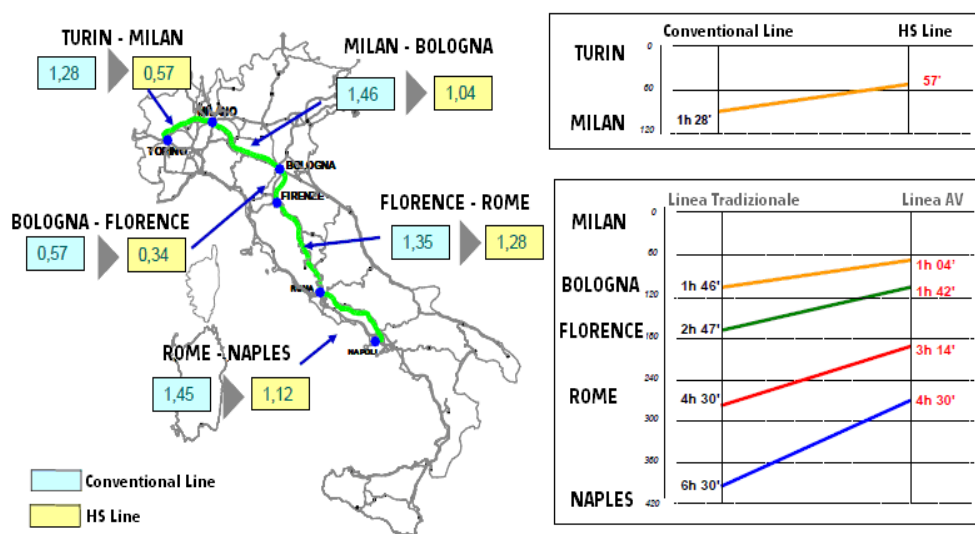

Figure 9: Journey time improvements on the HS/HC Italian line *Milan-Naples*

3.3 IMPLEMENTATION IN EUROPE

The HS/HC project began in 1991 as a **Turnkey project**, i.e.: a general Contractor is responsible for building the infrastructure and installing the technological system on each specific section. To maintain the technological uniformity on the work performed by each General Contractor on each HS/HC section, the technological system were built by a technological consortium, responsible for supplying the technological and signalling system for all the HS sections.

A railway line may be considered “high-speed” if trains that travel, at least reach a top speed of 200km. As of 2012 the maximum commercial speed is about 300 km/h for the majority of installed systems, but in some parts of Europe (Figure 10) a train running on a HS/HC line can reach the maximum speed of 350 km/h.

Spain (3800km), France (2000km), Germany (1600km) and Italy (1000km) are currently the most HS/HC equipped states in Europe.

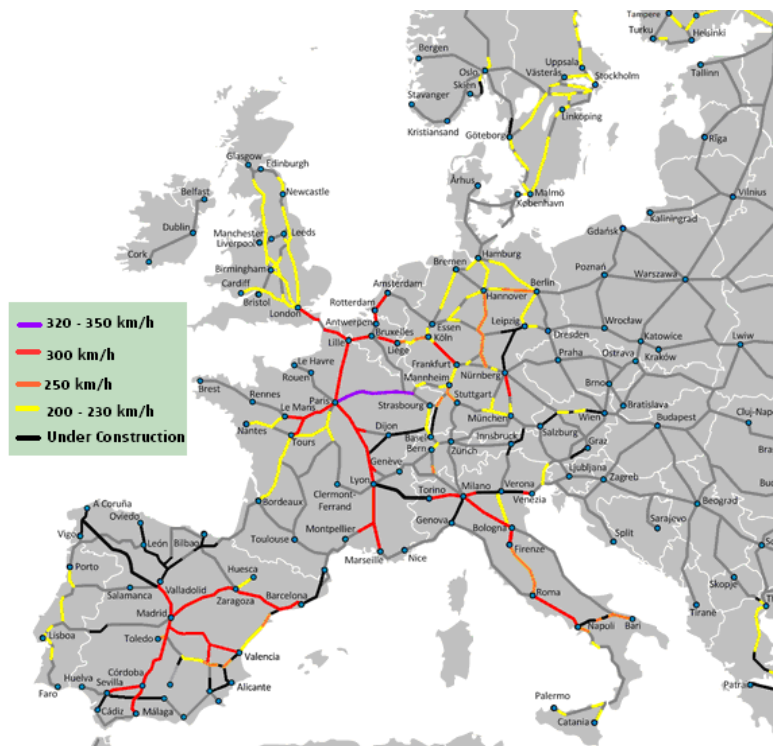

Figure 10: HS/HC railway European network

3.4 IMPLEMENTATION IN ITALY

Technical Features	
Type of traffic (passengers or freight)	Mixed
Max Speed	300 km/h
Minimum radius of curvature	5450 m
Maximum gradient	18%
Minimum radius of altitude fittings	10,5 cm
Maximum axle load	20 km
Seat width	25 t
Wheel tracks	13,6 m
Rail distance	4,5-5 m
Power of new lines	25 kV
Power of urban penetration whether	3 kV
Average distance among electrical substations	50 km
Section of natural galleries	82 mq

Table 3: Technical features of the HS/HC rail lines

The Table 3 just shown, presents is a brief description of the technological innovations that characterize the performance of the Italian HS/HC lines in terms of traffic safety, speed and interoperability. For detailed information, refer to [R4].

3.4.1 ERTMS/ETCS

On the HS/HC italian lines, the ERTMS / ETCS (or simply ETCS) L2 signalling system gives to the driver all the information necessary for safe driving, both in relation to the effects of its actions and to the changes in line conditions and with the activation of the emergency braking if the train speed exceeds the maximum allowed. For further information about this technology, refer to §5.

ERTMS / ETCS L2 is active with a maximum speed about of 300 km/h on the HS/HC lines Turin-Novara, Bologna-Florence and Rome-Naples.

3.4.2 GSM-R

It's the mobile communications system used exclusively in the railway sector.

With the **GSM-R** the railway infrastructure and its staff is equipped of a mobile radio system which can meet in an efficient and integrated, on a national scale, all the communication needs and data communications related with rail operations, including the control, safety, and journey of trains.

The GSM-R transmits on a frequency band in the range 900 MHz reserved for railway operations in Europe and provides communication services ground to train, both during normal circulation in cases of emergency.

The GSM-R allows a better and constant contact between the crew and the ground (service communications and emergency management) and allows the exchange of data between systems and information technology and the various European rails signaling through a single standard

interoperable communications. In this way, the perspective of European integration in rail traffic operations at the border for trains passing in the various European railway networks is facilitated.

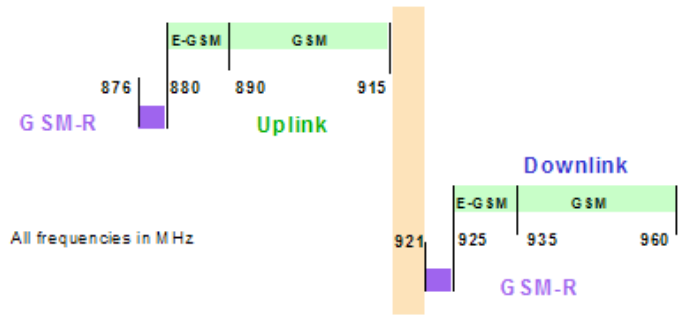

Figure 11: Frequency allocation in 900 MHz-Band

The transport companies have access to mobile telecommunications solutions and services conform to European specifications, which mean ensuring interoperability with mobile telecommunication systems of other European railways that are building similar GSM-R systems.

A simplified GSM-R infrastructure is presented in the following Figure 9. For detailed information, refer to [R10] and [R11].

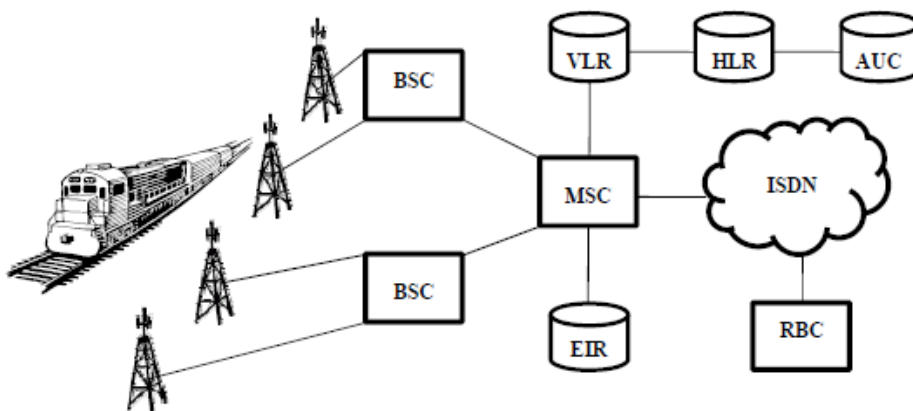

Figure 12: GSM-R Architecture

3.4.3 CSS - HS

The CSS – HS (Command and Control System – High Speed) is the most advanced integrated management system at a distance of movement used in the railway field. Developed to improve and ensure the regularity of trains in the process of upgrading the quality of services, to manage in an integrated circulation, diagnostics and maintenance, public information, surveillance and simplify management and obtaining the top timeliness and effectiveness in solving problems of movement even on high traffic lines. It’s a technologically advanced system that, by means of a logic computer, sends and receives commands from controls in security from electromechanical instruments (exchanges, signals) and apparatus (peripheral posts).

4 ERTMS PROGRAMME

4.1 SOME HISTORY ABOUT ERTMS

ERTMS is an international standard programme created to develop a common interoperable platform for railways, authority and signalling systems. Nowadays, the adoption of ERTMS is necessary on all the HS/HC railway lines, but it can be installed on a conventional line too.

The fundamental objectives of interoperability are based on the need to simplify, improve and develop international railway transport services, contribute towards gradually creating an open and competitive domestic market for the supply of railway systems and construction, renewal, restructuring and operative services, and establish standardised European procedures for assessing conformity with interoperability requirements.

For this purpose, the essential activities for achieving interoperability were the definition of a set of sub-system and components of the platform, specifying their essential requirements and interfaces by developing functional and technical specifications.

Then, at the end of 1993, the EU council issued an Interoperability Directive and a decision was made to create a group of railway expert called *ERTMS Group*, consisted originally of *DB*, *FS* and *SNCF*, but later joined by other railway European companies. The objective was to realize a structure to define the *TSI* (Technical Specification for Interoperability).

In the summer of 1998, the *UNISIG* union, comprising the European Signaling companies *Alcatel*, *Alstom*, *Ansaldo Signal*, *Bombardier*, *Invensys Rail* and *Siemens*, was formed to finalize the TSI of the ERTMS project.

This hierarchical process is well shown in Figure 13 below.

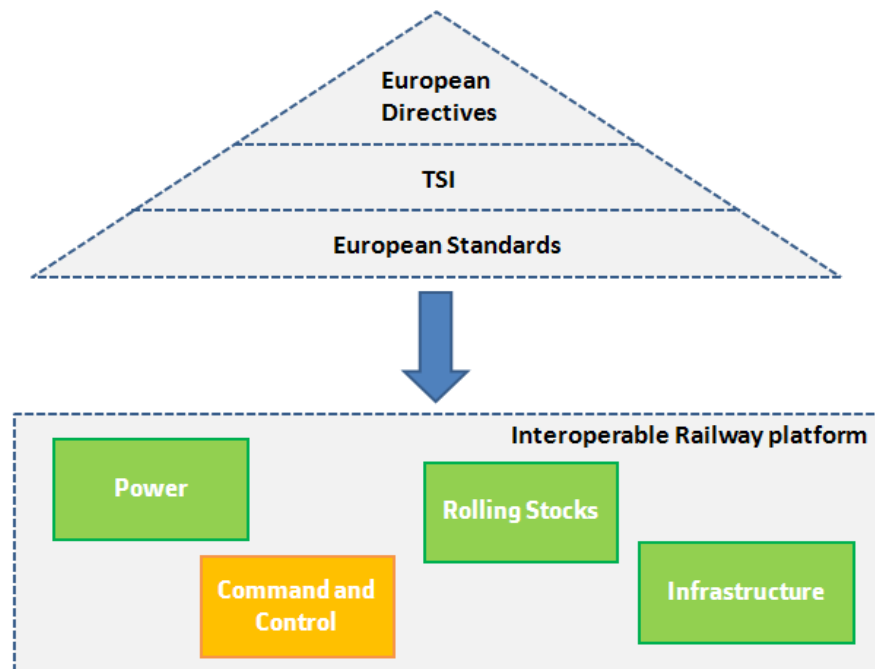

Figure 13: Hierarchic document level

As shown in the Figure 10 above, the third level, developed by UNISIG consortium, divided the whole interoperable railway platform into four main subsystems, each of which covers a different set of functional requirements.

The **command and control** subsystem chosen, which is a standardized, interoperable ATP/ATC system was called **ERTMS/ETCS** (or simply **ETCS**).

For clarity, in this paper we'll use the acronyms:

- **ERTMS**, to refer to the whole standard programme or railway platform
- **ETCS**, to refer to the signaling system, component of ERTMS programme

To allow the communication between trains, trackside and railway regulation control centres, the sub-system chosen is **GSM-R**, the international wireless communications standard for railway communication and applications.

For this reason, ERTMS programme can be defined as the combination of ETCS and GSM-R subsystems.

4.2 ADVANTAGES OF ERMTS

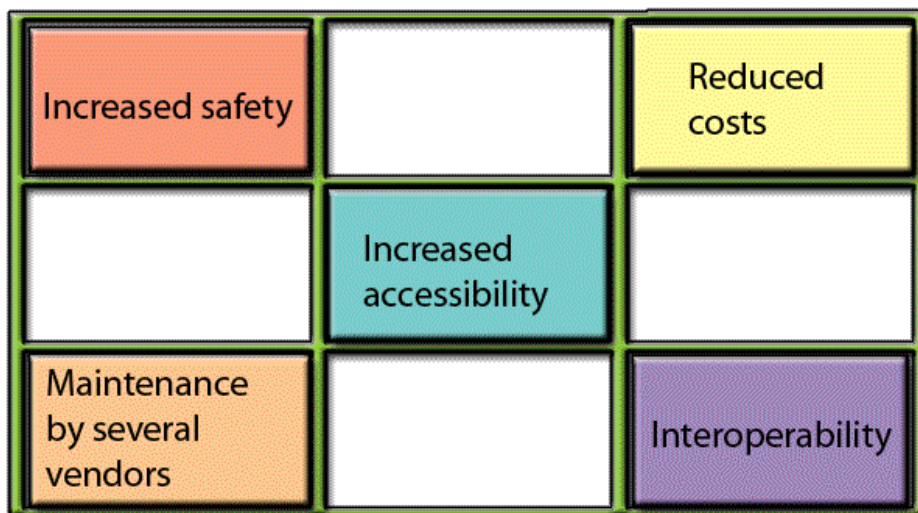

Figure 14: Performance increase with ERTMS

Figure 14 shows the advantages of the adoption of the ERTMS system in Europe, in terms of five main parameters:

Safety:

- constant speed monitoring
- signals received in the train
- direct surveillance of level crossing and avalanche information systems
- uniform european driver's panels
- **TSR** (Temporary Speed Reductions) sent to the network

Cost:

-
- no or reduced number of physical signals
 - fewer track magnets with cable connections
 - european standard
 - cheaper signal systems

Accessibility:

- reduced number of track magnets and no cables
- swifter error recovery with reduced number of systems

Interoperability

- standardised information screens for train drivers in Europe
- uniform technical interface between train and infrastructure
- uniform operative interface between train driver and infrastructure

Maintenance:

- standardised systems
- fewer critical safety interfaces
- one system per track
- several suppliers on the market

One of the objectives of this paper is, thus, to specify in more detail the features of this five parameters just described, showing how ERTMS system realizes a tangible performance increase in each of them.

4.3 MODIFICATION OF ERTMS/ETCS SPECIFICATIONS

Each new version, also called **Baseline**, of the UNISIG specifications is developed by the signalling company which constitute the consortium (Alstom, Siemens, Ansaldo, Bombardier, Site, Invensys rail, Thales) with an appropriate common migration strategy. This optimises management of the modification process of software-controlled systems in terms of costs and benefits.

Management of the modification of ERTMS/ETCS and GSM-R requirements is governed by the **ERA**, responsible for steering the modification process, including the issue of specifications, quality assurance and configuration management.



Figure 15: ERA logo

It acts as System authority, centralising and assuring complete consistency of the process. The railway stakeholders must be members of the **CCB** (*Change Control Board*), to establish the management of the modifications request, also called **CR** (*Change Request*).

The CCB must have a system outlook as regards modifications and a global assessment must be generated.

Figure 16 describes the process of managing modifications to the specifications and the development of the various versions of the specifications.

Alstom Transport SPA uses this formal process for the realization of the European HS/HC projects too.

On each baseline released for a signalling system, it's possible to open a change request, for two difference reasons:

- **Defect** if there's an error to correct in the development of the signalling system
- **Enhancement** if no error is found, but it's possible an improvement to the system

The change request is analyzed and, if considered as valid, it is assigned to an implementer, who has to realize the modification, which is applied on the next BL of the signalling system to be developed.

Just before the release of the BL, the CCB is met to review the status of the opened CR for defects or enhancement, deciding to approve or reject each one of them.

After the changes confirmation and the relative storage for memory, a new version (or baseline) of the signalling system is released.

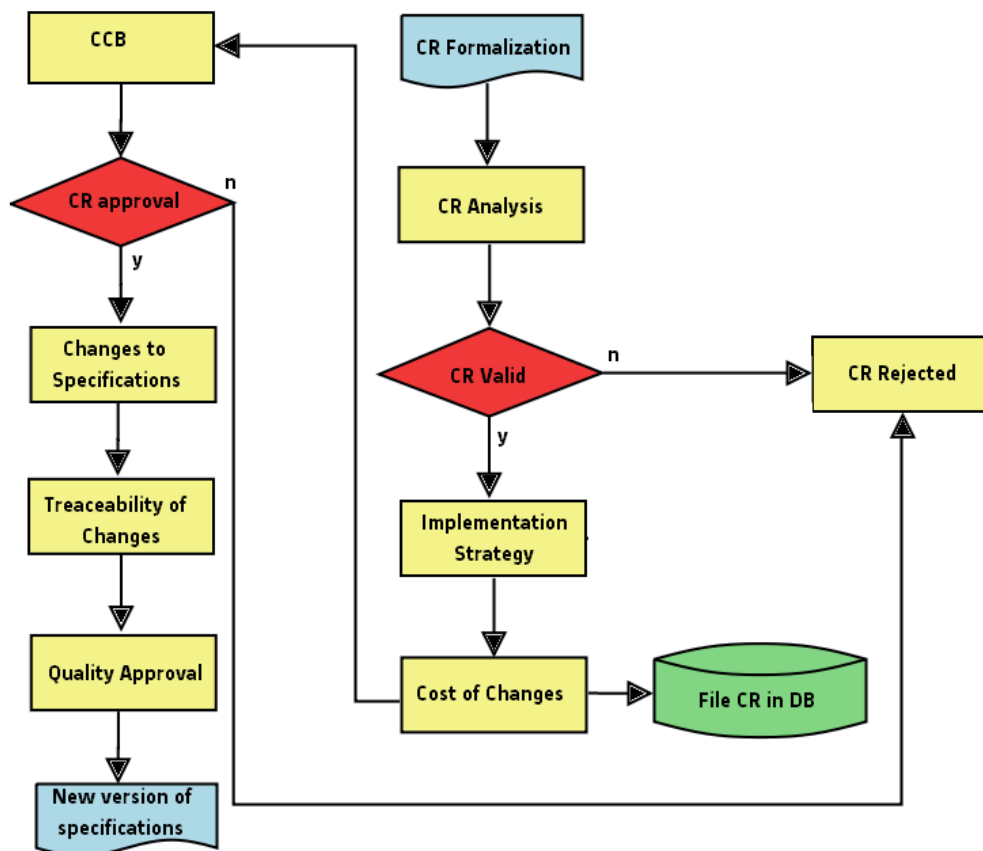

Figure 16: Change Request process for ERTMS/ETCS specifications

5 ETCS COMMAND-CONTROL AND SIGNALLING SYSTEM

As component (or subsystem) of ERTMS programme, ETCS is the standardized, interoperable **ATP/ATC system** used in Europe.

It is useful to specify that the classification of the ETCS system is not completely uniform. Some technical texts define it as an evolved ATP system and others consider it an ATC system because, while not including an ATO part:

1. The automatic brake is an operation does not require human intervention, thus, associated with an ATO system;
2. The train speed is highly supervised by the system and the driver only has to follow instructions that appear on the train cockpit (Figure 29).

In this paper we prefer referring to ETCS as an ATP/ATC system.

5.1 ETCS LEVELS

ETCS is divided into different functional levels. The definition of the levels depends on how the railroad is equipped and the way through information is transmitted to the train.

A train fitted with complete ERTMS/ETCS equipment and functionality can operate on any ETCS route without any technical restrictions. For detailed information, refer to [R13].

5.1.1 ETCS - LEVEL 0

One of the best advantages of the adoption of the ERTMS/ETCS standards is the absence of lateral signals. However, when an ETCS vehicle is used on a **non-ETCS route**, the trainborne equipment monitors the train for maximum speed of that type of train. Furthermore, the train driver has to observe the trackside signals.

5.1.2 ETCS - LEVEL 1

ETCS Level 1 is a cab signalling system that can be superimposed on the existing signalling system, i.e. leaving the fixed signal lateral system (national signalling and track-release system) in place. **Eurobalise** radio beacons pick up signal aspects from the trackside signals via signal adapters and telegram **LEU Encoders** and transmit them to the vehicle as a **Movement Authority** (permission to cross one or more block sections) together with route data at fixed points.

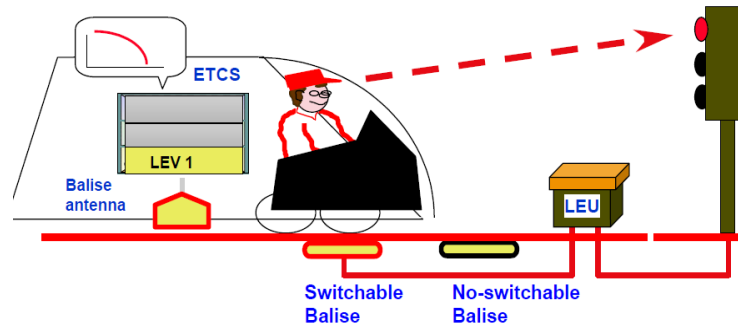

Figure 17: ETCS – Level 1 operation diagram

The on-board computer continuously monitors and calculates the maximum speed and the braking curve from this data. Because of the spot transmission of data, the train must travel over the Eurobalise beacon to obtain the next movement authority.

The ETCS Level 1 constitutes a *spot or semi-spot ATP/ATC* with interoperable Cab Signalling and fixed block.

This system is installed on HS/HC Austrian lines and in some sections of the British and Spanish lines.

5.1.3 ETCS - LEVEL 2

ETCS Level 2 is a digital radio-based signal and train protection system. *Movement authorities* are given to the driven in order to allow the train to move itself on the track and the most of the signals are displayed in the trainborne cab, substituting the lateral traditional signals. Thus, apart from a few *indicator panels* like overriding and border signals (these panels mark the extreme points of a block sections or of the ETCS L2 area, Figure 18) it is therefore possible to work without a lateral trackside signalling.

The train separation systems use the term *virtual signals*, because the concept of a traditional railway signal, like fixed light lamps, is physically moved to the train DMI (Driver Machine Interface, §5.2.2.2).

However, with track-release signalling devises like *track circuits*, the train integrity supervision still remains in place at the trackside. All trains automatically report their exact position and direction of travel to the **RBC** (Radio Block Centre) at regular intervals, through the GSM-R radio network.

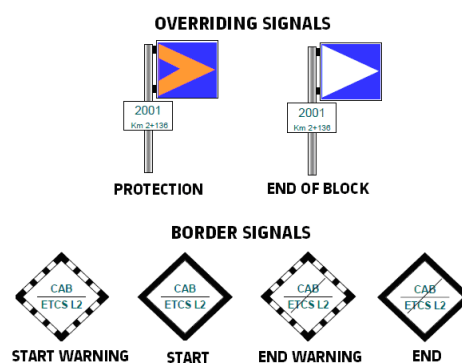

Figure 18: indicator panels

Train movements are monitored continually by the RBC. Any movement authority is transmitted to the train continuously via GSM-R together with speed information and route data, as shown in the Figure 19 below.



Figure 19: Exchange of information between RBC and trainborne

The Eurobalises are used at this level as *passive positioning beacons* or *electronic milestones*. Between two positioning beacons the train determines its position via sensors. The positioning beacons are used in this case as reference points for correcting distance measurement errors. The on-board computer continuously monitors the transferred data and the maximum permissible speed. The ETCS Level 2 constitutes a *continue ATP/ATC* with interoperable Cab Signalling and fixed block with block sections.

This system is installed on the Italian HS/HC lines Turin-Novara, Bologna-Florence and Rome-Naples.

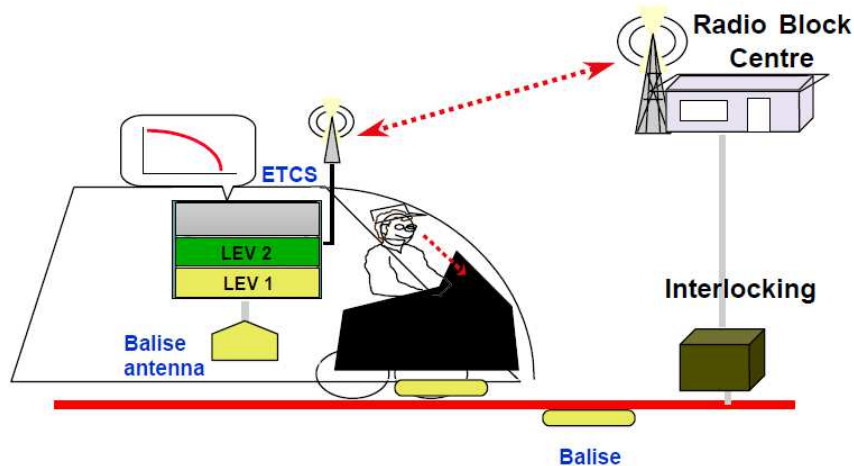

Figure 20: ETCS – Level 2 operation diagram

5.1.4 ETCS - LEVEL 3

ETCS Level 3 provides an implementation of full radio-based train spacing. Fixed track-release signalling devices are no longer required. As with ETCS Level 2, trains find their position themselves by means of positioning beacons and via sensors and must also be capable of determining train integrity on-board to the very highest degree of reliability. The route is thus no longer cleared in fixed track sections. In this respect ETCS Level 3 departs from classic operation with fixed intervals, because it calculates safe distance between two trains.

A movement authority is given on the information relating to the position of the train, based on the actual distance of a train from the next. This solution called **absolute braking distance spacing** or **moving block**, ensures a greater exploitation of the capacity of the line as it reduces the granularity of the spacing.

Level 3 is currently under development.

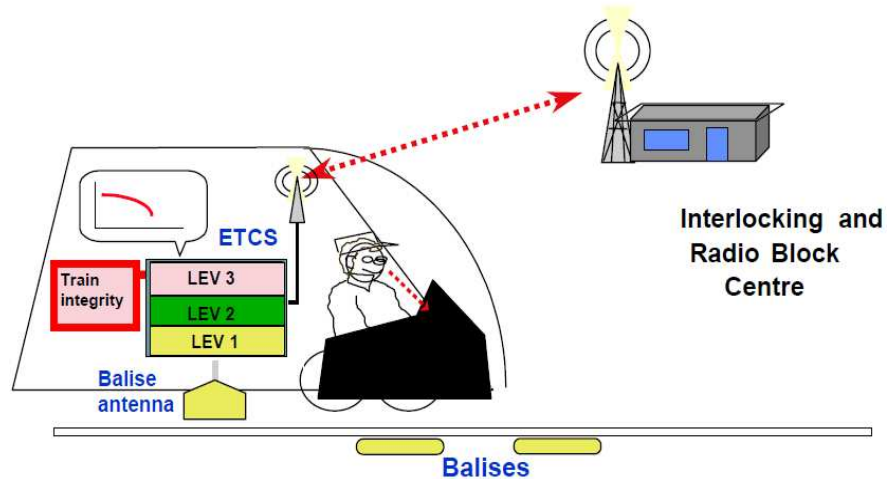

Figure 21: ETCS – Level 3 operational diagrams

As shown in the previous figures, for each ETCS level, the trainborne subsystem must also implement the previous level.

ERTMS Level 2 is currently the most widely used version and we refer to it in the following sections of this paper.

5.2 ARCHITECTURAL DESCRIPTION

A HS/HC rail line can be equipped of a complex transport system equipped with an ETCS L2 signalling system solution, able to control trains movements, in order to guarantee the safe and regular traffic operations.

The next Figure 19 shows the simplified structure of the Ground and Trainborne systems, which together form the HS/HC Transport System.

The whole Ground System, supplied for the HS line by a railway company. These systems comprise the power and telecommunication **HSSS** (High Speed Signalling System) and a ground trackside subsystem with:

- Train control and distance separation subsystem (**ETCS**)
- Line management subsystem, called **IXL** (Interlocking)
- Train command and supervision subsystem (**ATS** or **TMS**)

It is described in details in §5.2.1.

The trainborne System comprises mainly:

- On-board **HSSS**;
- **EVC** (European Vital Computer);
- **DMI** (Driver Man Interface);
- **Odometry** subsystem.

It is described in details in §5.2.2.

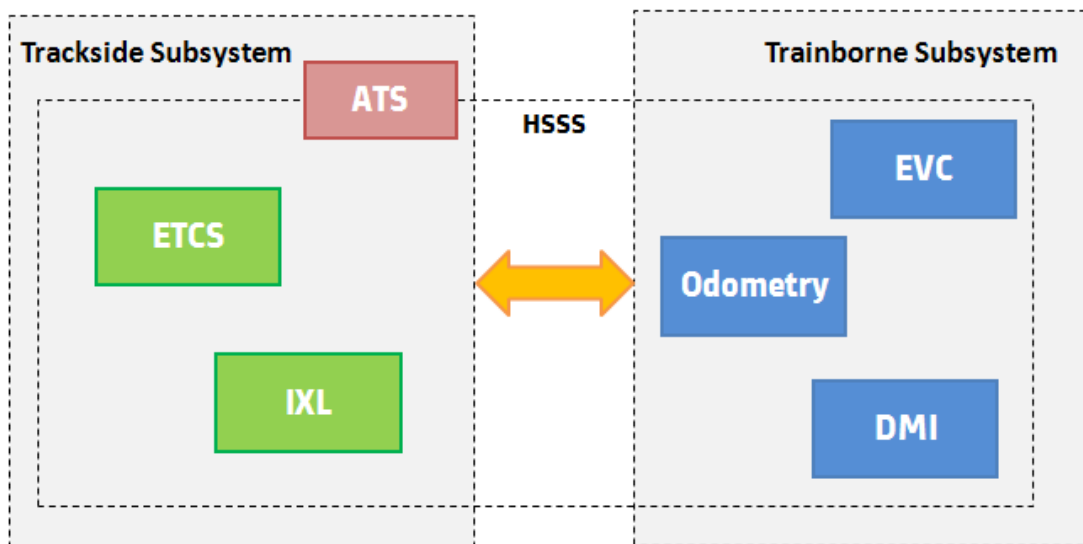

Figure 22: HS/HC railway transport system

5.2.1 TRACKSIDE SUBSYSTEM

The trackside subsystem, communicate with the other external elements as shown in Figure 23. In the Figure 19 upon, it's possible to recognize the two different following sub-systems:

1. ETCS
2. IXL
3. ATS or TMS

Each of them is briefly described in this section of the paper, from a functional and architectural point of view.

As an application example, we report in this section the architecture for the Alstom trackside signalling subsystem installed on the *HSL Bologna-Florence*, extended to the *HS bypass*, which connects the "Milan-Bologna" and "Bologna-Florence" HSL without passing through the "Bologna Centrale station", ensuring faster journey time.

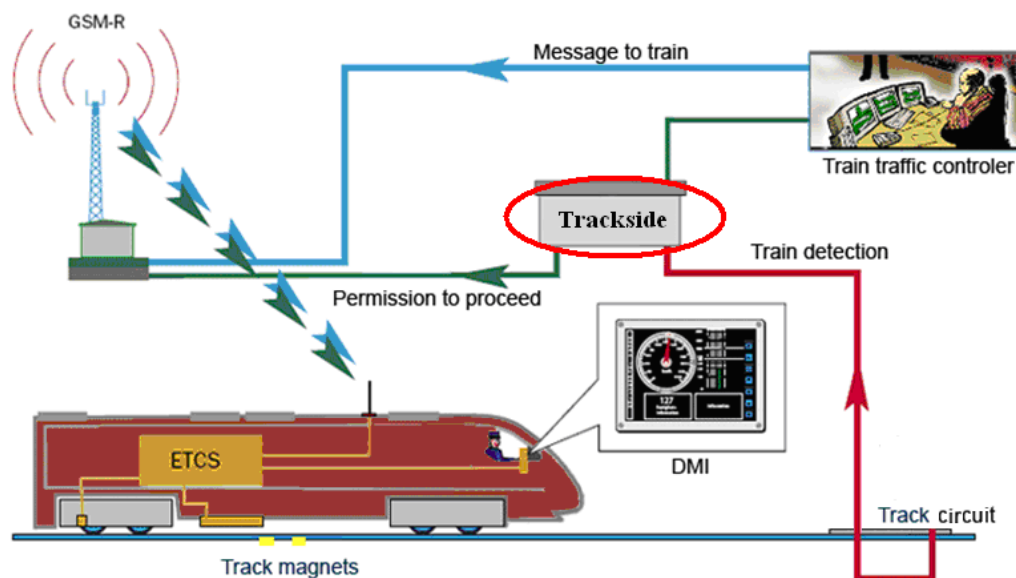

Figure 23: Communication of the trackside subsystem with other ERTMS L2 elements

5.2.1.1 ETCS

The ETCS L2 system realizes the two following main function:

1. **Ensure the safe space separation among the trains** working on the HS/HC line
2. **Monitor the travel of the train**, advising the driver if he pass a red (danger) signal or exceed a speed restriction. In these cases, the system applied an automatic brake if the driver fails responding to the warnings.

On the Italian HS/HC lines, it is called **SDT** (*Sistema Distanziamento Treni*).

In the next paragraphs, we describe the main components of these subsystems, currently used on *HSL Bologna-Florence*. For detailed information, refer to [R5] and [R13].

5.2.1.1.1 RBCs

RBC (Radio Block Center) is the heart of the ERTMS/ETCS level 2 trackside system.

It is the safe central trackside equipment of the ERTMS/ETCS level 2 and is responsible for the security of all trains running in the level 2 area with which a GSM-R communication has been established.

In other words, RBC manages the exchange of data required for safe train travel and separation, but only in its area of governance responsibility (70 km, Figure 24).

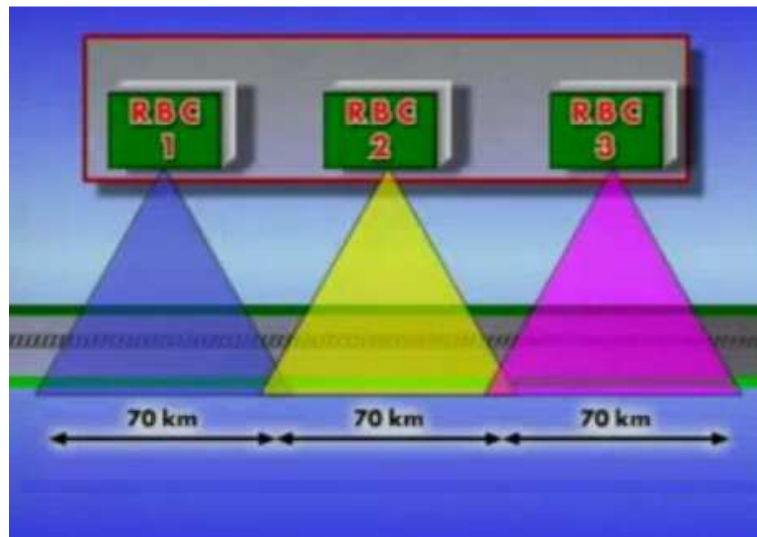

Figure 24: RBCs area governance responsibility

Each RBC:

- Sends movement authorities to trains according to the information received from the Interlocking, such as route occupancy, route state, etc.
- Receives information from trains through position reports.

The exchange of data between the RBC and trains is done through the GSM-R communication network.

Each RBC calculates each train position and records it in its own data base (this data base includes also the track layout). This way, every train in communication with the RBC shall be supervised at any moment.

When a train running on an ETCS L2 fitted line is going to overpass a specific RBC Area, this means in a few km it will approach the next RBC Area, so the two adjacent RBCs have to exchange the train information in order to permit the train running without less of performance.

This exchanging process is called **HandOver**.

The RBC whose area is left by the train during the handover process is called *Handing Over RBC* (RBC_{HO}), while the RBC in whose area the train enters is called *Accepting RBC* (RBC_{ACC}).

5.2.1.1.2 NTG

The **NTG** (Network Transmission Gateway) is an interface gateway between signalling equipment network and GSM-R subsystem network. The NTG converts the information coming from the RBC into GSM-R protocol and vice versa, allowing the communication between the RBC and with ERTMS/ETCS level 2 equipped trains.

The NTG is the equipment that interfaces between the RBC and the GSM-R network and converts the information coming from the RBC into GSM-R protocol and vice versa allowing the communication between the RBC and with ERTMS level 2 equipped trains.

One NTG is able to communicate with several RBCs and trains at the same time.

5.2.1.1.3 KMS

The **KMS** (Key Management System) is the trackside component in charge of the management of cryptographic keys on the railway, to facilitate secure ERTMS data radio communication.

ERTMS exchanges information between trackside equipment and trains and vice versa in the form of data messages. When radio is used for these data messages a secure connection is required and corresponding keys must be available on either side of the connection.

KMS component is basically composed of two different equipments, which performs different tasks: **KMC** (Key Management Centre) and **PKI** (Public Key Infrastructure).

Key Management Centre (KMC) is part of the KMS; it is in charge of generating, updating and dispatching the authentication keys into the ERTMS trackside and trainborne equipment and to exchange keys with foreign KMCs (same equipments belonging to an adjacent line).

Public Key Infrastructure (PKI) is used for the management of asymmetric key material. The key material is usually managed through Smart Cards or similar hardware.

For more details about the security issues into the ERTMS architecture, refer to §5.3.3.4.

5.2.1.1.4 EUROBALISES

The Eurobalises, called *track magnets* in Figure 23, is the equipment installed on the track that sends ETCS messages to trains. In ETCS level 2, it is mainly used for train location management. The Eurobalises is considered to be **fixed** if it always transmits the same message stored in its internal memory. It's mainly used to provide trains with the needed information for the relocation on board function and to inform the RBC at the station facility about train positions via position reports.

In the opposite case (variable messages), we can talk about of **switchable Eurobalises**.



Figure 25: Eurobalises on a railway track

5.2.1.1.5 LEU

The LEU (Lineside Encoder Unit) is the safe equipment that interfaces between the *Interlocking* and other external system, and the switchable Eurobalises installed on the track.

This equipment is able to interface with several switchable Eurobalises at the same time. It sends the suitable predefined ERTMS/ETCS messages, according to the information received from the Interlocking or external system.

5.2.1.1.6 MARKER BOARDS

The ETCS marker board are installed along the track at each end of block section. They are used to indicate to the train driver the exact location where he needs to stop the train in the case of end of movement authority.

An ETCS marker board is a coloured and reflecting panel in order to be visible from a far distance.



Figure 26: ERTMS/ETCS Marker boards

5.2.1.2 IXL

If the train had to follow only a single track between an origin and a destination, an ATP/ATC system like the one just presented would be roughly adequate.

Indeed, home and destination of a rolling stock is typically a station and there is more than a path (**Path 1**, **Path 2**) to go from an initial point A, to a final point B (Figure 27).

A station consists of a number of parallel rails greater than two and their switches, which give the possibility to route trains on different tracks. The path of a train leaving a station from the beginning is called *route*.

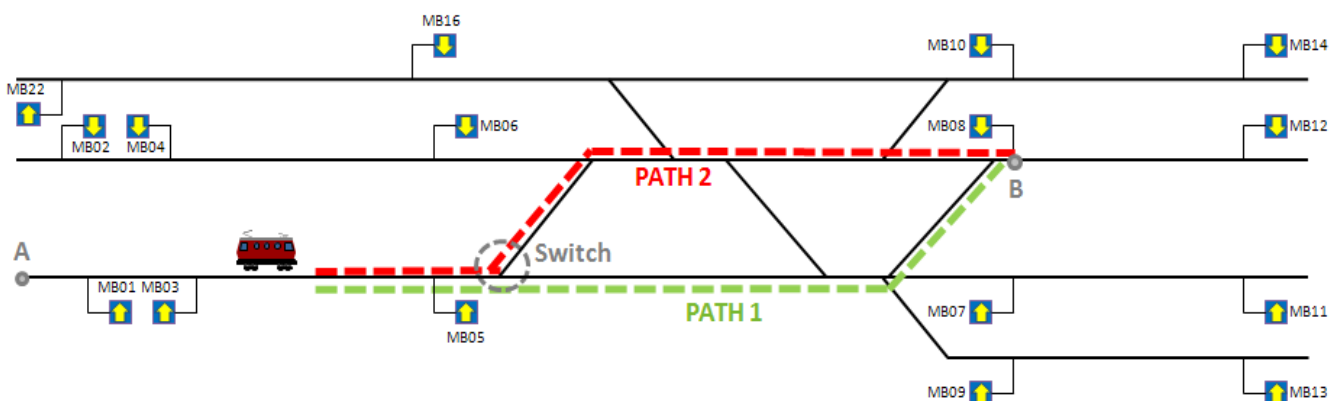

Figure 27: Two possible routes from A to B

The control system that deals the line management and, thus, the **routing of trains**, is called **interlocking**. Setting a route means locking a several number of block sections, which together form a path for a train. Until the route is active and its track circuit occupied, trains cannot obtain any part of the route, which is considered as a mutually exclusive shared resource.

On Italian HS/HC lines, it is called **GDV** (*Gestione della Via*).

5.2.1.3 ATS

The **ATS** (Automatic Train Service) or **TMS** (Traffic Management System) subsystem is devoted to supervise the railway traffic circulation and to perform the diagnostics of the equipment of the system, Interlocking/RBC equipment included.

It supports the complete Traffic Management life cycle, with functions to plan, regulate and optimize the train traffic circulation, to manage the infrastructure state, to monitor and to perform diagnostic of all involved equipment.

All those functions share a single integrated Human Machine Interface for displaying real-time status of the railway line, managed by a human supervision.



Figure 28: HS/HC Bologna TCC

Figure 28 shows the Alstom **TCC** (Traffic Control Center), part of the ATS subsystem and located in Bologna, where a group of men, called *train dispatchers*, daily command and control the status of the Bologna-Florence HS/HC line.

5.2.2 TRAINBORNE SUBSYSTEM

The trackside ETCS subsystem, called on Italian HS/HC lines **SSB** (*Sottosistema di Bordo*), communicates with the trainborne subsystem in order to allow the rolling stock's safe movement.

5.2.2.1 EVC

EVC (European Vital Computer) is the on-board computer, which safely processes the trainborne functions on the basis of the:

1. information received from the wayside equipment
2. data introduced by the driver
3. data coming from on-board sensors

EVC is physically placed on board through the rack like the one just shown, realized by Alstom for the Italian SSB. The driver can interface with EVC through the **DMI** (Driver Machine Interface).

5.2.2.2 DMI

The DMI is the main means of interaction between the driver and the system. It is used to:

1. display signals and indications via a monitor in every driver cab;
2. acquire entered data and enable specific functions via a series of keys and buttons;
3. achieve technical interoperability on the driver side.



Figure 29: ERTMS/ETCS Cockpit

As shown in Figure 30, the displays on the DMI monitor are located in specific areas depending on their meaning. In the lower part of the figure, a particular focus is given to the *speed control area*, which displays:

1) Instantaneous speed

It's the true train speed and it is shown on the monitor as a digital tachometer with a circular scale and central indicator. In Figure 27 is shown a digital tachometer, with a scale up to 400 km/h, indicating an instantaneous speed of 104 km/h.

2) Warning intervention time

It's a vertical segment, with a decreasing length. It's the remaining intervention time for the cab driver

3) Maximum speed permitted

It is indicated by the upper limit of the tachometer.

4) Target speed

Target speed is indicated by the point of the arc where change the colour. It's the speed witch the train has to reach just before the target\danger point. It's shown by a circular arc and indicated by the upper limit of the tachometer.

5) Target distance

It's the remaining distance between the train and target\danger point.

6) Release speed

A release speed is a speed limit under which the train is allowed to run in the vicinity of the EOA, when the target speed is zero. One release speed can be associated with the Danger Point, and another one with the overlap. Release speed can also be calculated on-board the train. It is indicated in the outer part of the circular arc representing the permitted speed; a digital representation is provided as well.

Note the different colours between the two circular arc speeds in the lower and upper parts of the Figure 30. The use of certain colours responds to a predefined sequence of priorities, which establishes the colour criteria shown in Table 4.

Urgency	Colour	Driver Action
Low Priority	grey	No immediate action is required
Average Priority	yellow	An appropriate action (i.e: train braking) is required to the cab driver
High Priority	orange	An immediate corrective action (i.e.: increased breaking) is required
Very High Priority	red	The required action has not been performed

Table 4: Colour DMI criteria

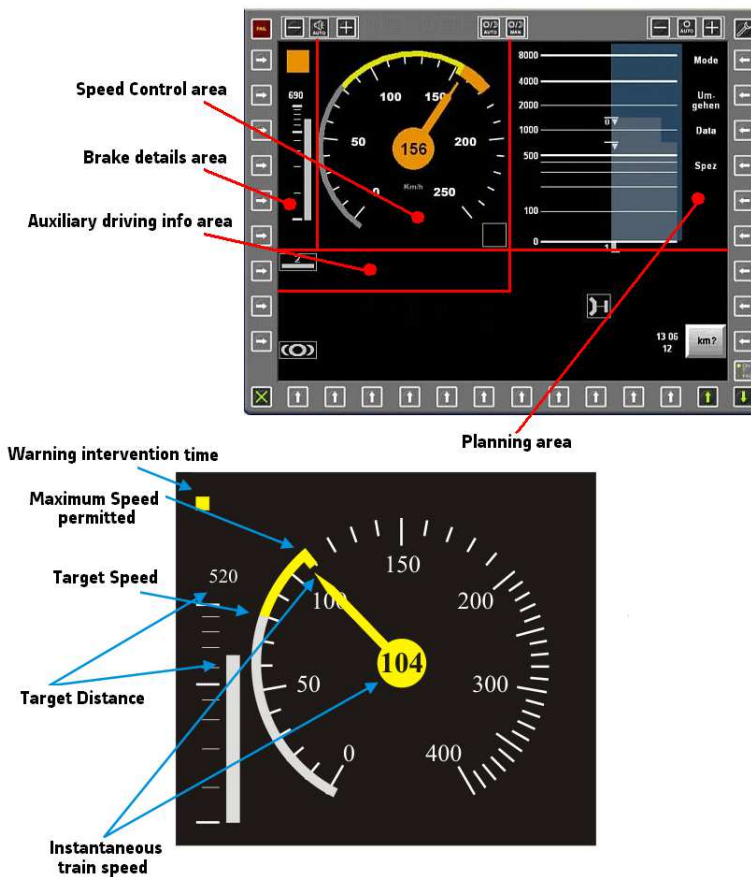

Figure 30: ETCS DMI monitor

5.2.2.3 Odometry subsystem

The *Odometry* is a technique for estimating position and speed of a vehicle on wheels, based on information from sensors for the measurement of the covered distance. An odometer measures the covered distance of a vehicle by sensing the rotations of its wheels, featuring from a given size\radius. F

Since it's applicable to all vehicles with a constrained guide, the railway systems commonly use this technique. Thus, concerning the on-board system, the odometry subsystem is composed of the equipment described on the next paragraphs, which provides to the EVC the needed information to calculate the distance run by the moving train and its speed.

EVC is able to calculate each of these values cyclically, between two defined points of the track P_1 , P_2 , identified by two different balises. When the train passes the point P_2 , its position is updated and the process of estimating odometry restarts.

Figure 28 below shows a simplified scheme of the on-board system, where the light-blue boxes represent the main equipment of the odometry subsystem. For detailed information, refer to [R14], [R15] and [R16].

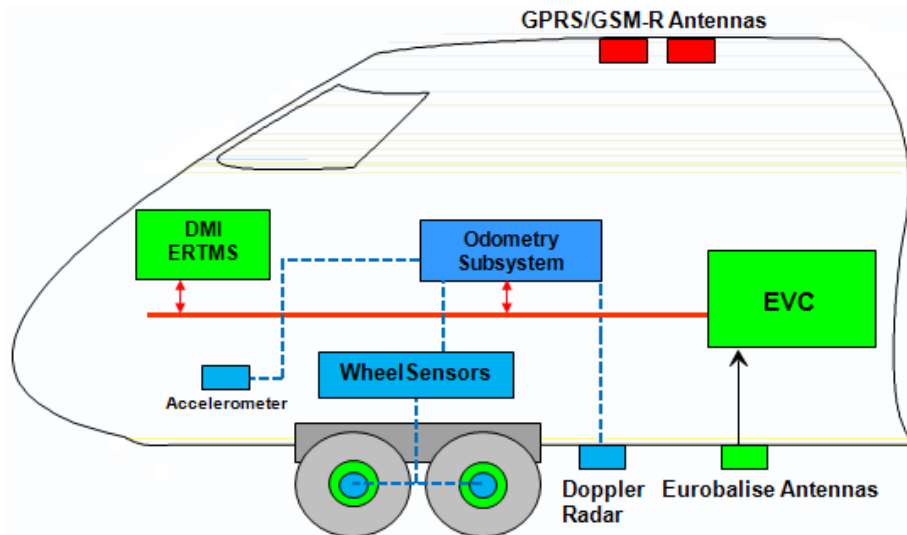

Figure 31: Simplified On-Board System

5.2.2.3.1 Wheel Sensor

The running speed of moving vehicles is calculable knowing the rotation speed of its wheels. This calculation is based on odometry techniques and the consequent covered distance is based on the assumption that wheels turn linearly in relation to the ground.

The measurement of the speed of a rotational axle and, by extension, of a wheel, is practicable by means of an incremental rotary encoder, placed on the wheel.

Regarding the characterization of this device, it's called:

- **Rotary** (also called a **shaft encoder**), due to the fact it's an electro-mechanical device that converts the angular position or motion of a shaft or axle to an analog or digital code.
- **Incremental**, because it's able to calculate the shift distance, without knowing anything about the initial position.

It provides a specified amount of pulses in one rotation of the encoder. The output can be a single line of pulses (an "A" channel) or two lines of pulses (an "A" and "B" channel) that are offset in order to determine the speed rotation.

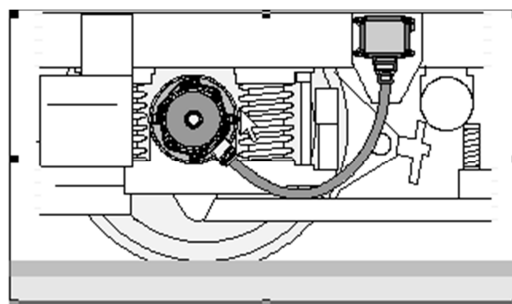

Figure 32: Wheel Sensor

5.2.2.3.2 Radar

Based on the Doppler principle, the radar sensor gives an image of the ground displacement in order to provide information about train speed and covered distance.

Microwaves transmitted by aerial are reflected by ground. The Frequency difference between emitted and received radiation, proportional to train speed, is computed by a processing unit. The radar sensor contains embedded software and is powered by the train battery.

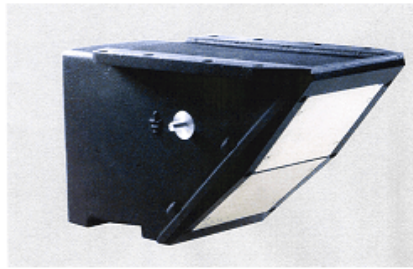

Figure 33: Radar Sensor

5.2.2.3.3 Accelerometer

In standard trainborne configuration an accelerometer is used and provides the ETCS trainborne sub-system with the train acceleration/deceleration.

The accelerometer is based on force balance principle. Submitted to acceleration, the seismic mass tends to move. The new position is detected by an optical position detector and converted into a current. This current is proportional to the acceleration.

The accelerometer provides an output voltage proportional to the train acceleration by passing through an accurate load resistor.



Figure 34: Accelerometer

5.3 FUNCTIONAL DESCRIPTION

This section describes some of the ETCS L2 principles, whose functions are implemented on the *Alstom High Speed Bologna-Florence* line, extended to the *HS bypass*.

Each of functions covered can regard both the trackside subsystem and the trainborne subsystem.

5.3.1 TRACKSIDE SUBSYSTEM

5.3.1.1 IMPROVED SAFETY

5.3.1.1.1 Movement Authority

A train travelling on an ERTMS L2 equipped railway needs a permission to cross every block sections which comprises the line, called **MA** (*Movement Authority*).

For this purpose, the permission to proceed is given from the trackside to the trainborne. When needed, limitations related to the movement authority, i.e: mode profile for *On Sight*, *Limited Supervision* or *Shunting*. Mode profile is always being sent together with the MA to which the information belongs.

For further information about the operative modes of a train which runs on an ETCS equipped line, refer to the right next section.

Whenever the system detects that a virtual signal (marker board) that is part of an MA given to a train is replaced to danger, the MA will be revoked by sending a **CES** (Conditional Emergency Stop) to the train.

Figure 35 below shows a part of the Alstom **VMMI-ERTMS simulator** interface, customized for the HS/HC Italian line *Bologna-Florence*. In this example, a movement authority is given to the train "1" from the track circuit 121 to the 2020, so a green segment is drawn on the interested sections. In the figure, this area is highlighted by a red rectangle.

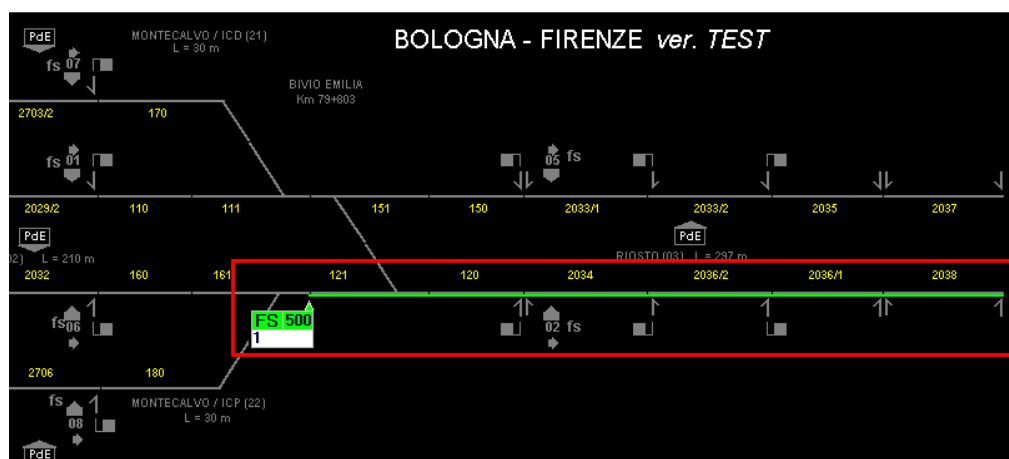

Figure 35: Allocation of a Movement authority

5.3.1.1.2 Temporary Speed Restriction

A TSR is a speed restriction temporarily set for different reasons, like working staff on the track. To define a TSR, at least the following data shall be introduced during the data preparation phase of the project in case of predefined TSR, or by the TCC operator in case of dynamic TSR:

- The starting point of the TSR, regarding the track layout.
- The ending point of the TSR, regarding the track layout.
- The maximum allowed speed between the starting point and the ending point.
- The ending condition, regarding the train's length. The TSR ending condition indicates at what moment the TSR has to be considered as no more applicable on board.

Figure 36 below shows a part of the VMMI-ERTMS simulator interface, customized for the HS/HC Italian line *Bologna-Florence*. In this example, a TSR is imposed from the track circuit 121 to the 2020, so a yellow segment is drawn down the interested sections. In the figure, this area is highlighted by a red rectangle.

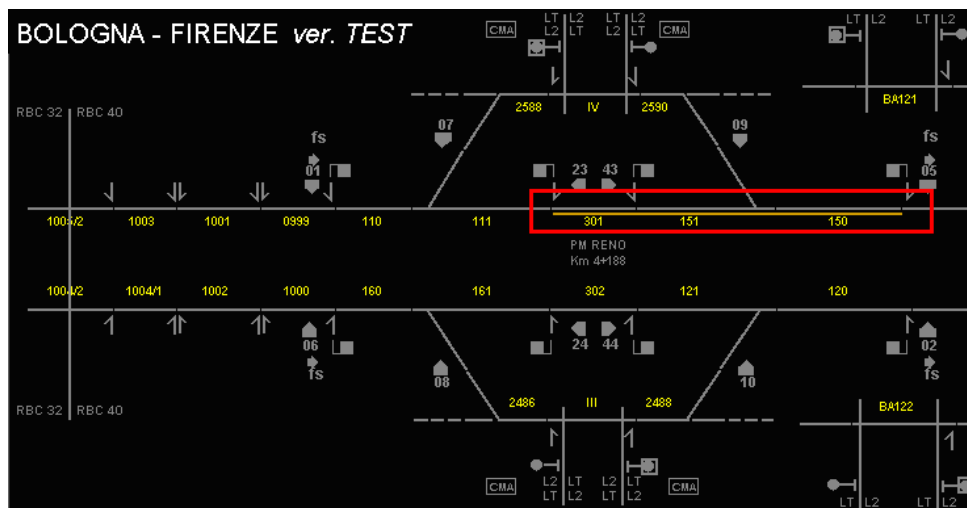

Figure 36: Allocation of a temporary speed restriction

In this framework, we can distinguish two different kind of TSR:

- Predefined TSR
- Dynamic TSR

Predefined TSRs are planned *during the engineering process* and implemented into the RBC data base. Any predefined TSR defined in the RBC internal data base can be automatically activated according to information received from the Interlocking (e.g. in relation with sensors in the track).

Once the TSR is activated in the RBC data base, it shall be sent to the train only when it is inside the path assigned by the RBC to this train. If no train is approaching the TSR area, no TSR shall be sent. Predefined TSR are usually used to limit the train speed at well-known areas when known events are raised. For example, they can be activated as result of the activation of a trackside detector or other external electrical signal.

Dynamic TSRs are defined *during the operation of the line*. They are introduced by the TCC operator and sent afterwards to the RBC.

Once the TSR is defined in the RBC data base, it shall be sent to the train only when it is inside the path assigned by the RBC to this train. If no train is approaching the TSR area, no TSR shall be sent.

5.3.1.1.3 Dynamic Speed Monitoring

The ETCS L2 ATP function called dynamic speed monitoring is the supervision of the speed of the train versus its position, in order to make the train to respect the Most Restrictive Speed Profile and Limit of Authority/End of Authority.

The **MRSP** (*Most Restrictive Speed Profile*) is a description of the most restrictive speed restrictions the train shall obey on a given piece of track.

The on-board continuously supervise a list of targets (i.e. speed decrease of the MRSP, LoA, EoA, max distance in SR mode). Depending of the type of the target, the on-board calculates a specific curve; from this first curve several others are calculated defining several limits. By comparing the actual speed and location of the train to the various limit curves, the ETCS board generates indications to the driver and braking actions.

The following supervision limits are defined:

- **Pre-indication location**: informs the driver that he is approaching an area where he has to operate the service brake in order to brake to a target;
- **Indication (I)**: informs the driver that the train speed is approaching the maximum allowed speed in that area;
- **Permitted Speed (P)**: the maximum speed the train is allowed to run;
- **Warning (W)**: If the train speed exceeds the Warning curve, an audible warning is issued to the driver to indicate that he should start braking;
- **Service Brake Intervention (SBI)**: if the driver fails to obey the command to brake within a predefined time, the train speed will overpass the SBI limit the on-board equipment will apply the service brake until the allowed speed has been reached;
- **Emergency Brake Intervention (EBI)**: if the train speed is such that this limit is overpassed, the emergency brake will be applied;
- **Release speed monitoring start location**: the release speed may be necessary for two reasons. One is that a train has to be able to approach the EOA where the permitted speed reaches zero and might be too restrictive to permit acceptable driving due to inaccuracy of the measured distance. The other reason is that in a level 1 application the train has to be able to overpass the balise when the signal clears. For these two reasons a (low) release speed may be given from trackside or may be calculated on board, based on the distance from the EOA to the Supervised Location.

5.3.1.1.4 Detectors

Information coming from detectors as tunnel or hot box detector information can be forwarded to the Interlocking and up to the RBC. According to this information, the RBC can automatically activate a predefined TSR and send it to the approaching train.

A direct reaction can also be foreseen by connecting the detector outputs to the encoder, which shall activate the corresponding predefined TSR and shall send it to the associated Eurobalises.

As several possibilities for sending predefined TSR exist, the final implementation depends on each project and on each particular case. A safety study has to be achieved during the project phase.

Other possibility is to automatically send conditional (CES) or unconditional emergency stop (UES) messages after detector activations.

5.3.1.2 ASSURED INTEROPERABILITY

In this section innovative functions which realize an interoperable system, are reported.

Thanks to them, an ETCS equipped train can move among traditional and high speed lines, even if starting and ending journey points are in two different countries.

5.3.1.2.1 Entrance Transition Announcement

Trains approaching the ERTMS/ETCS L2 area shall be informed of the distance remaining in front of it up to the entry border. This Eurobalise group (transition announcement Eurobalise group) shall include all information related to the entrance point and transition conditions.

In addition to the distance, the train shall be informed through the transition announcement Eurobalise group of the transition level to be performed once the entry point has been reached.

The physical installation of this Eurobalise group shall be done a given distance before the ERTMS/ETCS level 2 border in order to give time enough for the train and RBC to exchange the necessary information for preparing the entrance. In addition, the driver shall be asked to acknowledge the level 2 transition before the entrance becomes effective.

This distance is line-speed dependent and shall be determined during the design phase of the project according to track plans (line topology) and speed profiles.

The number of "transition announcement" Eurobalise groups shall be determined during the design phase of the project and after the corresponding safety and availability detailed studies.

The "transition announcement" Eurobalise group is usually switchable as it is usually installed at the same location that the last wayside optical signal before the entrance (optical signal protecting the entrance) and before a point. In case there is no point before the entrance, a fixed Eurobalise group can be used.

5.3.1.2.2 First Movement Authority

The ERTMS/ETCS L2 system shall verify that the approaching train is the only one and that no other train is also entering. This shall be done by interfacing with the adjacent signalling system, mainly with the adjacent IXL

If it is the case, the system shall send to the train its first movement authority to be applied from the border point. The application of this movement authority at the exact border point is an on board function.

5.3.1.2.3 Entrance with train not fitted with ERTMS/ETCS L2

In order to protect the entrance of the ERTMS/ETCS level 2 area and avoid not fitted trains to enter the area, several methods have been implemented by Alstom:

- A signal managed by the interlocking and located at entrance is red until the RBC sends a movement authority to the train. As the not fitted train will not receive any movement authority, the signal will stay red and the train will not enter the ERTMS/ETCS level 2 area.
- An information containing the train running number is sent to the control center. Based on it and on its timetable, the operator will permit or not the access to the ERTMS/ETCS level 2 area to the entering trains.
- A Eurobalise of the adjacent national system is located at the entrance and protects the ERTMS/ETCS level 2 Area by sending information to stop the train. As train fitted with ERTMS/ETCS level 2 will have already switched to ERTMS/ETCS system, they will not take into account the Eurobalise message and they will not be stopped.

5.3.1.3 IMPROVED PERFORMANCE

5.3.1.3.1 INCREASED INFRASTRUCTURE CAPACITY

Today, railway operations in several parts of the world and in Europe in particular require a constant and increasingly intense flow of trains on busy routes.

Before explaining how ETCS L2 covers this requirement, helping the reader of this paper, Table 4 presents an overview of the terminology used in this paragraph.

Term	Explanation
Occupation Time	The time a block section (the length of track between two block signals, cab signals or both) is occupied by a train.
Buffer time	The time difference between actual headway and minimum allowable headway.
Headway distance	The distance between the front ends of two consecutive trains moving along the same track in the same direction. The minimum headway distance is the shortest possible distance at a certain travel speed allowed by the signalling and/or safety system.
Headway time	The time interval between two trains or the (time) spacing of trains or the time interval between the passing of the front ends of two consecutive (vehicles or) trains moving along the same (lane or) track in the same direction.

Table 5: Short description of rail capacity terminology

Some of the terms described are further illustrated in the following diagram.

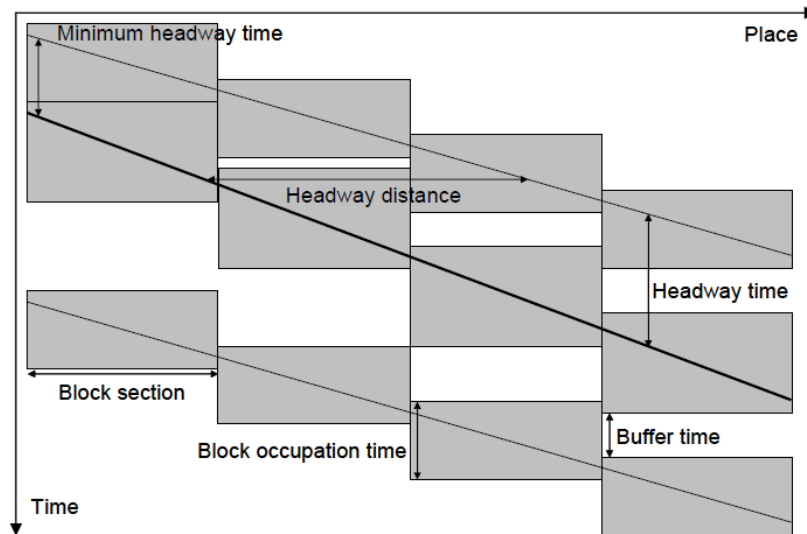

Figure 37: Rail capacity parameters

By allowing a reduction of headways between trains, signalling systems play a major role in increasing capacity on railway networks, as more trains can run on the same track.

In this framework, ETCS L2 offers considerable benefits in terms of infrastructure capacity. So, how can signalling affect rail infrastructure capacity?

Whilst signalling originally aims to control railway traffic safely and avoid collisions between trains, it increasingly plays an important role in increasing capacity, i.e. influencing the number of trains on a given line and the distance between them, and has therefore become a crucial part of railways' competitiveness.

In the early days, "Movement Authorities" were passed on to train drivers by flagmen or elevated flags located on the various sections of the track. These were replaced over time by lineside signals (traffic lights) which are nowadays still largely present on most railway networks.

Now ATP will automatically apply the brakes if the driver fails to respect the Movement Authority – thereby removing the risk of a human error and allowing for higher speeds and shorter headways between trains.

However, signalling is not the only way to increase capacity on a given rail network.

In fact, there are a number of options to increase capacity, from building additional lines or renewing existing tracks, lengthening trains and loops or platforms, to operating more frequent services and higher density trains.

Opting for a modern signalling system like ETCS, operators may easily increase the frequency of trains on a given line. Instead of building another line or lengthening trains and platforms, upgrading to ERTMS represents the easiest, most economic and least disruptive way of increasing capacity on a line or network.

Infrastructure capacity is always a result of several technical and operational factors and this makes it difficult to provide a generic figure.

However, it is commonly acknowledged and demonstrated by experience that the moving from a conventional trackside signalling system to a cab-signalling ATP system like ETCS, with an appropriate block system, enables up to 40% capacity increase on currently existing infrastructure.

As the most recent signalling system, ETCS is publicly acknowledged to have better performance in terms of capacity than its predecessors. This is due to the cab signalling features and the ability of ETCS to take into account the braking compatibilities of each individual train.

Basically, the use of ETCS L2 can offer considerable advantages in terms of capacity increase. Indeed, when using L2 a continuous stream of data informs the driver of line-specific data and signals status on the route ahead, allowing the train to reach its maximum or optimal speed but still maintaining a safe braking distance factor. This therefore enables higher operational speeds and reduced headways.

5.3.2 TRAINBORNE SUBSYSTEM

5.3.2.1 OPERATING MODE

The trainborne ETCS L2 subsystem can take on various status and operating modes. For detailed information, refer to [R19].

Each one of them guarantees a different safety level of driving. Where appropriate, a symbol displayed on the DMI indicates the mode that is currently selected:

1) *Full supervision (FS)*

This is the normal non-permissive movement authority, giving full protection. The train is permitted to run at the maximum speed shown and it's supervised against a dynamic speed profile. This mode cannot be selected by the driver, but it is entered automatically by the On-Board Unit when all train and track data, necessary for a complete supervision, is available on-board.

2) *On sight (OS)*

This movement authority allows the train to enter into a track section that could be already occupied by another train, or obstructed by any kind of obstacle. The train must proceed at such a speed that it can stop short of any obstruction. The speed is supervised against a dynamic speed profile. This mode cannot be selected by the driver, but it is entered automatically by the On-Board Unit when commanded by trackside and all necessary conditions are fulfilled..

3) *Shunting (SH)*

This mode is used during shunting movements. The train's speed is supervised up to a ceiling speed. A list of expected balise groups can be sent by the trackside equipment: in such case, if a balise group not contained in the list is passed, the train is tripped. The train is tripped also if a "stop if in shunting mode" information is received from balise group. Display of the Shunt symbol is not an authority to move the train. This mode can be entered by the driver or ordered by trackside.

4) *NoN-leading (NL)*

This mode is selected on the rear traction unit when running in tandem or banking, etc. It provides limited supervision.

5) *Staff responsible (SR)*

This mode allows the train to be moved under the driver's own authority on an ERTMS equipped line. The train's speed is supervised up to a ceiling speed. A list of expected balise groups can be sent by the trackside equipment: in such case, if a balise group not contained in the list is passed, the train is tripped. The train is tripped also if a "stop if in SR" information is received from balise group. A given distance is also supervised, and the train is tripped if it overpasses this distance.

6) *Standby (SB)*

This is the default mode, automatically selected when opening or shutting down the driver's desk. The ERTMS/ETCS on-board equipment performs the standstill supervision.

7) Unfitted (UN)

This mode is selected when driving on lines not fitted with ERTMS. The DMI will display no information other than the train's speed, which is supervised up to a ceiling speed provided by national data. Also temporary speed restrictions are supervised by the ERTMS/ETCS on-board equipment.

8) Trip (TR)

This mode is automatically selected in the event of a movement authority being exceeded, until acknowledged by the driver. An emergency brake demand will occur and the reason of the trip displayed.

9) Post trip (PT)

This mode is entered automatically once the train has come to a stand and the driver has acknowledged the trip. The command brake is then released..

10) Sleeping (SL)

Where a locomotive or unit has more than one set of ERTMS/ETCS on-board equipment, only one set can be active at any time. The other sets will be in sleeping mode. In this mode no train supervision is performed.

11) System failure (SF)

This mode is associated with failure of the ERTMS/ETCS on-board equipment and is accompanied by an emergency brake demand.

12) No power (NP)

This mode is entered when no power is applied to the ERTMS/ETCS on-board equipment. It is accompanied by an emergency brake demand. Some parts of the On-Board Unit may be fed by an auxiliary power supply.

13) Isolation (IS)

This mode applies when the driver has isolated the ERTMS following a failure.

14) National System (SN)

This mode allows the National System to access some resources of the ERTMS/ETCS on-board equipment.

15) Reversing (RV)

The Reversing mode allows the driver to change the direction of movement of the train and drive from the same cab, i.e. the train orientation remains unchanged. This shall be possible only in areas so marked by trackside. Reversing areas shall be announced in advance by trackside. This mode is used to allow the train to escape from a dangerous situation and to reach as fast as possible a "safer" location. In this mode a ceiling speed and an allowed distance are supervised.

16) Limited Supervision (LS)

The Limited Supervision mode enables the train to be operated in areas where trackside information can be supplied to realise background supervision of the train. Limited supervision cannot be selected by the driver, but shall be entered automatically when commanded by trackside and all necessary conditions are fulfilled. The ERTMS/ETCS on-board equipment shall supervise train movements against a dynamic speed profile. The Limited

Supervision mode enables the train to be operated in areas equipped with lineside signals where ETCS does not have information regarding the status of some signals, i.e. not all signals are fitted with LEUs or connected to an RBC. The driver must observe the existing line-side information (signals, speed boards etc.) and National operating rules.

17) Passive Shunting (PS)

The Passive Shunting mode is defined to manage the ERTMS/ETCS on-board equipment of a slave engine (NOT remote controlled, but mechanically coupled to the leading engine), being part of a shunting consist. This mode can also be used to carry on a shunting movement with a single engine fitted with one on-board equipment and two cabs, when the driver has to change the driving cab.

5.3.2.2 START OF MISSION

The driver of an ETCS fitted train may have to perform the procedure **SoM** in order to allow the train starting its movement along the track, according to the planned operative modes and the ERTMS/ETCS level:

- a) Once the train is awake, OR
- b) Once shunting movements are finished, OR
- c) Once a mission is ended, OR
- d) Once a slave engine becomes a leading engine

For each connection related to an end section point, a “safe” zone called **TAF** zone must be associated, in which the ERTMS/ETCS L2 signalling system can guarantee that the train is the first one in the block and the section located downstream the train is not occupied.

The common point of all the situations involving the achievement of the function “Start of Mission” is that the ERTMS/ETCS on-board is in SB mode. At the beginning of the Start of Mission procedure, the data required to the driver are:

- Driver ID
- ERTMS/ETCS level
- RBC ID/phone number
- Train Data
- Train Running Number
- Train Position (known, invalid, unknown)

If the train position data stored in the on-board equipment is of status “invalid” or “unknown”, the information shall be transmitted to the RBC via the “SoM position report” message.

If the position report is validated by RBC, the ERTMS/ETCS on-board equipment is informed that the train is accepted without valid position data, so it shall delete the train position data (new status: “unknown”).

Consequentially, the train is set to SR until the next BG, when it’s able to send a valid position report to RBC.

Here, the situations for which train position is invalid/unknown at start-up are listed:

-
- Train comes from mode IS, SF, NP (with no cold movement detector)
 - Train moved in IS, SF, NP mode

If the train is running in a degraded mode (as at the beginning of the procedure “Start of Mission”), ensuring that the train is the first one in the block and the section located downstream the train is not occupied, is mandatory.

In a level 2/3 area, the ERTMS/ETCS on-board equipment shall be able to handle a *TAF Request* given by the RBC. The track ahead free request from the RBC shall indicate to the on-board:

- a) at which location the ERTMS/ETCS on-board equipment shall begin to display the request to the driver.
- b) at which location the ERTMS/ETCS on-board equipment shall stop to display the request to the driver (in case the driver did not acknowledge)

The driver shall have the possibility to acknowledge the track ahead free request (meaning the driver Confirm that the track between the head of the train and the next signal or board marking signal position is free).

When the driver acknowledges, the ERTMS/ETCS on-board equipment shall stop displaying the request, and shall inform the RBC that the track ahead is free.

There shall be no restrictive consequence by the on-board system if the driver does not acknowledge. A new track ahead free request shall replace the one previously received and stored.

5.3.2.3 INCREASED SPEED

In general and specifically for the ETCS equipped trains, the term maximum speed can have many meanings. It can reflect:

- **Maximum average speed** between two scheduled stops based on the running times in timetables daily operation.
- **Maximum speed at which a train is allowed to run safely** as set by law or policy on a straight section in daily service with minimal constraints
- **Maximum speed** at which an unmodified train is proved to be capable of running.

Official absolute world record for conventional train is held by the French **TGV**.

In April 2007, a specially tuned train, reduced to three cars with higher voltage, broke the world record, reaching 574.8 km/h, the highest ERTMS speed until now.



Figure 38: TGV speed world record

5.3.3 INTERFACE BETWEEN TRACKSIDE AND TRAINBORNE SUBSYSTEMS

The ERTMS/ETCS L2 trackside signalling subsystem communicate with the **OBU** (On Board Unit):

1. Through the NTG gateway, by the exchange of RBC Radio messages on a GSM-R channel
2. Through the Air Gap interface, by the transmission of Eurobalise telegrams.

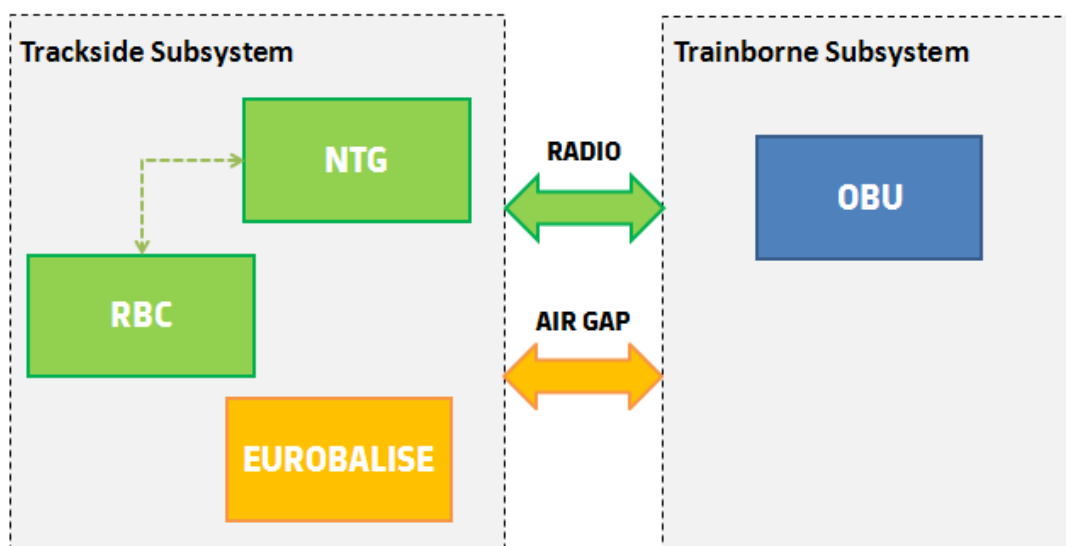

Figure 39: Interface between Trackside and Trainborne Subsystems

5.3.3.1 RADIO Interface

5.3.3.1.1 GSM-R

The GSM-R, just generally described in §3.4.2, is the mobile communications system which allows the exchange of data between an ERTMS L2 fitted train and the trackside subsystem.

This wireless and connection-oriented approach is often considered as the bottleneck of the signalling system, which considerably limits the possible number of voice and data connections in each cell of the network at the same time and it can cause a deadlock of the system, if the number of users will rapidly increase (e.g. accidents, freight depots, lines with a high and dynamic volume of traffic).

5.3.3.1.2 GPRS-R

A packet-switched approach should be analyzed to counteract this expected deadlock by taking into account that the GSM-R infrastructure, which is often already installed by the national railroad operators, also should be used to save the high capital investment of these railroad operators.

In public wireless networks the packet-switched **GPRS** (*General Packet Radio Service*) was used to increase the possibilities of the already existing wireless infrastructure. Currently the amount of data used for signalling within connection-oriented ETCS Level 2 environment is very small and in most cases there are no transmissions for a long time interval. However, the classical GSM scheme keeps the transmission channel busy, due to its circuit-switched behaviour. A full GSM channel is reserved for each transmission channel used. Supplementary services, e.g. operational communications, are thus limited and the use of the bandwidth is not the really efficient. A deadlock of the system will occur if the number of parallel ETCS Level 2 controlled trains will be on the track. With GPRS the transmission channel is only used when data must be transmitted.

The following presents a classical GPRS infrastructure. The major differences between a packet-oriented GPRS infrastructure and a connection-oriented GSM infrastructure consist in two further network elements which are described as follows.

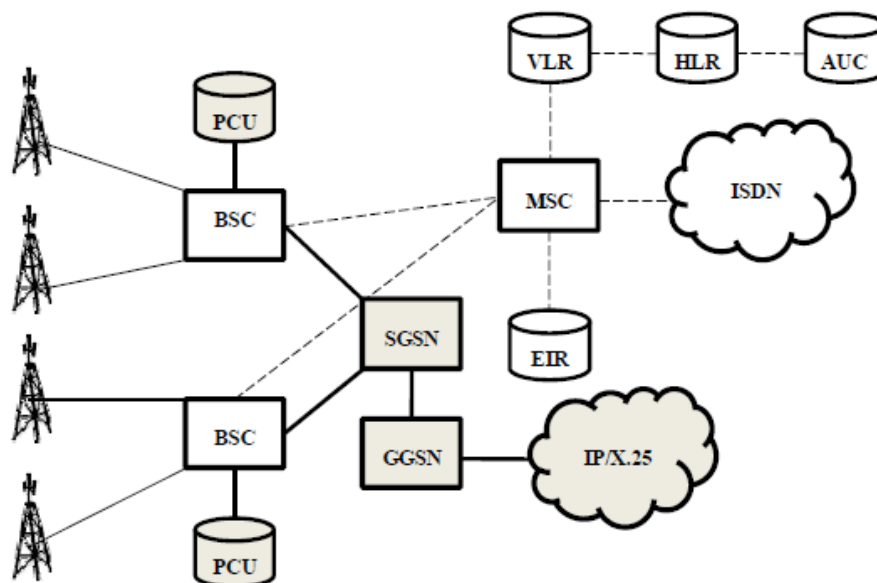

Figure 40: GPRS-R Architecture

The **SGSN** (*Serving GPRS Support Node*) is responsible for the delivery of data packets from and to the mobile stations within its geographical service area. Its tasks include packet routing and packet-transfer, the mobility management, the logical link management and, finally, the authentication and charging functions.

The **GGSN** (*Gateway GPRS Support Node*) acts as an interface between the GPRS backbone network and the external packet data networks. It converts the GPRS packets coming from the SGSN, mentioned before, into the appropriate **PDP** (*Packet Data Protocol*) format and sends them out on

the corresponding packet data network. In the other direction, the addresses of incoming data packets are converted to the GSM address of the destination user. The re-addressed packets are sent to the responsible SGSN.

Once GPRS is activated, a virtual continuous connection between the network participants (e.g. train and RBC) is established. During a session, a user is assigned to one pair of uplink and downlink frequency channels. This is combined with time domain statistical multiplexing, i.e. packet mode communication, which provides the common use of one frequency for several users. Only if information (e.g. ETCS telegrams, described in §5.3.3.3.3) must be transmitted, the radio link will be reserved by a user.

In fact, one of the highest problems for data transmissions in “standard GSM” is the limited size of the data fields on each slot. GPRS fixes that inconvenience by using 4 consecutive GSM data slots, which constitute a 456 bit GPRS data block. Once this block is defined, multiple Coding Schemes can be implemented through the transmitted data coming from upper layers.

For these reasons, the GPRS-R technology will be implemented in the future in order to realize the whole communication between trackside and trainborne ERTMS/ETCS L2 subsystems. For detailed information, refer to [R17].

5.3.3.2 AIR Gap Interface

The Air Gap interface realizes the Eurobalise Transmission System, a safe spot transmission based system conveying safety related information between the wayside infrastructure and the train.

More precisely, the Air Gap permits the communication between the Eurobalises installed on the wayside and the On-board Transmission Equipment.

For detailed information, refer to [Ref. 7]. Here, we can simply explain that when a train passes over a Eurobalise:

- The OBU provides a signal for transmitting the required power (*Tele-powering signal*) used for activating the Eurobalise;
- The activated Eurobalise sends to the train an *ERTMS/ETCS telegram*;

Thus, as shown in Figure 38, this interface is splittable into the following two sub-interfaces:

- *Interface A1*, used for transmitting telegrams (Up-link) from the Balise to the OBU Antenna Unit.
- *Interface A2*, used for transmitting the required power (Tele-powering) from the OBU to the Eurobalise

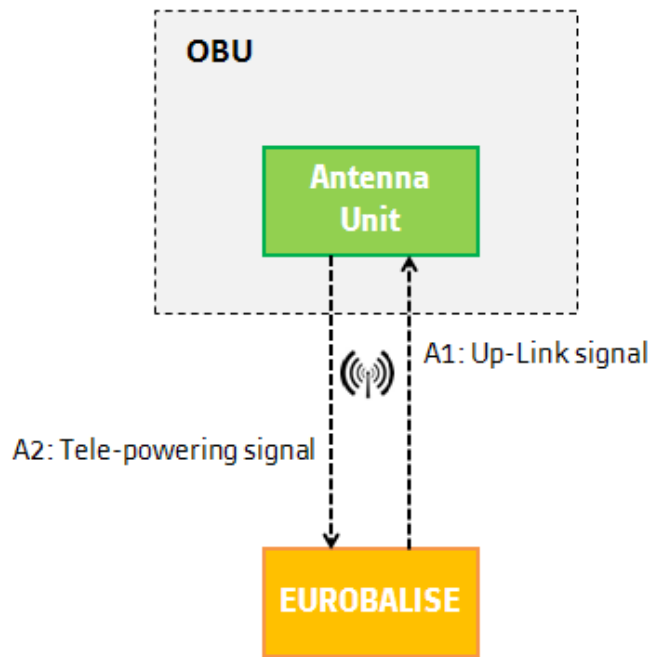

Figure 41: Air Gap Interface

5.3.3.3 ERTMS/ETCS Language

The applicative data exchanged between the trackside (RBC and Eurobalises) and the trainborne (OBU) subsystems are called *Telegrams*. They are structured and encoded using the ERTMS/ETCS language.

The ERTMS/ETCS language is based on variables, packets and messages, organized according to a specific and standard syntax, fully specified in [Ref. 22].

5.3.3.3.1 Variables

ERTMS/ETCS variables are used to encode single data values and cannot be split in minor units. Each variable unambiguously identify a specific track entity, allowing the system to handle the data to be evaluated.

The following Table 6 shows an example of a variable treated by the ERTMS/ETCS system, the purpose of which is to identify the univocal number of a level crossing on the track.

Name	NID_LX		
Description	Identity number of the Level Crossing.		
Length of variable	Minimum Value	Maximum Value	Resolution/formula
8 bits	0	255	Number
Special/Reserved Values	127-255	Reserved for RBC transmission	

Table 6: Variable “NID_LX”

5.3.3.3.2 Packets

ERTMS/ETCS Packets are used to group multiple variables into a single unit, with a defined internal structure. This structure consists of a packet header with:

- A unique packet number
- The length of the packet in bits
- The orientation information
- The distance scale and an information section containing a defined set of variables

(optionally)

The packet structure is as follows:

Variable	Purpose
NID_PACKET	Number - Packet identifier
Q_DIR	Direction - Specifies the validity direction of transmitted data
L_PACKET	Length - Number of bits in the packet
Q_SCALE	Scale - Specifies which distance scale is used for all distance information within the packet.
Information	Well defined set(s) of variables

Table 7: Structure of an ERTMS/ETCS Packet

5.3.3.3.3 Messages

ERTMS/ETCS messages (telegrams) are composed of one header, a predefined set of ERTMS/ETCS variables (when needed), a predefined set of ERTMS/ETCS packets (when needed) and optional packets as needed by application. The transmission order in ERTMS/ETCS messages respect the order of data elements listed in the message format (from top to bottom).

As example, here two telegrams sent by RBC to the OBU, are described in term of triggering functions, which activate the sending process and data structure.

5.3.3.3.3.1 Message 2: SR Authorization

The ERTMS/ETCS trackside subsystem has to issue to the train the “Message 2: SR Authorization” if the following conditions are fulfilled:

1. The OBU operating mode is “SR” and a MA Request is received from the OBU;
- OR*
2. The OBU operating mode is “SB” or “PT” *and*
 3. No TAF Window is configured *and*
 4. The train position is invalid or unknown *and*
 5. A MA Request is received from the OBU.

The following diagram in Figure 39 graphically describes what’s just presented.

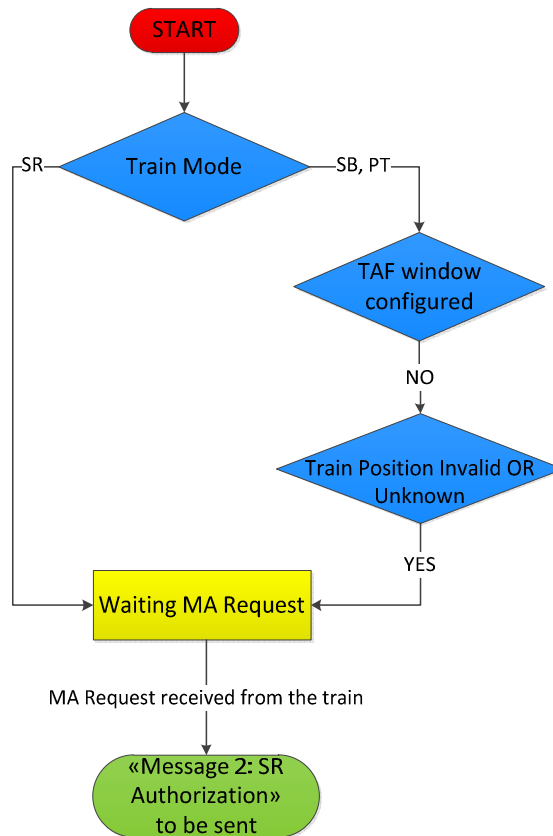

Figure 42: Triggering functions for “Message 2: SR Authorization”

The following Table 8 shows the data structure of the message:

<i>N</i>	<i>Variable Name</i>	<i>Variable Value</i>
1	<i>NID_MESSAGE</i>	2
2	<i>L_MESSAGE</i>	12
3	<i>T_TRAIN</i>	Time, according to trainborne clock, at which message is sent
4	<i>M_ACK</i>	1
5	<i>NID_LRBG</i>	Balise identity number of last relevant balise group (NID_BG)
6	<i>Q_SCALE</i>	0
7	<i>D_SR</i>	32767

Table 8: Message 2 - SR Authorization

5.3.3.3.2 Message 3: Movement Authority

The ERTMS/ETCS trackside subsystem has to issue to the OBU the “Message 3: Movement Authority”:

1. Only through the RBC which is responsible of the train (Supervising RBC).
2. Only to trains with validated train characteristics and for which an internal route (path) has been created and assigned.
3. Only to trains with a validated position inside the area supervised by RBC.
4. Only to trains for which there is no Emergency Stop Messages pending.

5. Only to trains for which there is compatibility between the OBU characteristics and the portion of the railroad covered by the MA.

The following Table 9 shows the data structure of the message:

N	Variable Name	Variable Value
1	<i>NID_MESSAGE</i>	3
2	<i>L_MESSAGE</i>	<i>It depends by Optional Packets</i>
3	<i>T_TRAIN</i>	Time, according to trainborne clock, at which message is sent
4	<i>M_ACK</i>	1
5	<i>NID_LRBG</i>	Balise identity number of last relevant balise group (NID_BG)
6	<i>Level 2/3 Movement Authority</i>	Packet Number 15 - Transmission of a movement authority for levels 2/3
7	<i>Gradient Profile</i>	Packet Number 21 - Transmission of the gradient
8	<i>Static Speed Profile</i>	Packet Number 27 - Static speed profile and optionally speed limits depending on the international train category.
9	<i>Optional Packets</i>	

Table 9: Message 3: Movement Authority

5.3.3.4 ERTMS Security

This section will be available soon.

What has been written without passion,
will be read without pleasure.

Samuel Johnson